



Sparkling Science >
Wissenschaft ruft Schule
Schule ruft Wissenschaft

Caterina Benigni und Aileen Opelt

**Synthesis of Electroluminescent
Oligothiophenes**

Diplomarbeit der HBLVA für chemische Industrie, Wien

betreut von

DI Dr. Renate Tlustos-Ziegler
HBLVA für chemische Industrie, Wien

**Univ.Ass. DI Dr. Ernst Horkel und
o. Univ.Prof. DI Dr. Johannes Fröhlich**
Technische Universität Wien

ao. Univ.Prof. DI Dr. Marko D. Mihovilovic
Projektleitung „Grüne Chemie“
Technische Universität Wien

BMWF Schriftenreihe
Abschlussarbeiten von Schülerinnen/Schülern
und Studierenden im Rahmen des Programms
Sparkling Science
Heft 7, Wien 2011

BM.W.F^a

www.bmwf.gv.at
www.sparklingsscience.at

Bundesministerium für Wissenschaft
und Forschung

Diese Arbeit wurde am 28. Mai 2009 eingereicht,
verfasst im Rahmen des Forschungsprojektes
**„Grüne Chemie“ – Nachhaltige Strategien
in der Wissenschaft**

PROJEKTLEITENDE EINRICHTUNG

Technische Universität Wien, Institut
für Angewandte Synthesechemie
Projektleitung: ao. Univ.Prof. DI Dr. Marko D. Mihovilovic
Kontakt: mmihovil@pop.tuwien.ac.at

BETEILIGTE SCHULEN

BG/BRG St. Veit an der Glan, Kärnten
BRG Feldkirchen, Kärnten
BG/BRG Villach, Kärnten
BG/BRG Tulln a.d. Donau, Niederösterreich
GRG Sachsenbrunn, Niederösterreich
HTL Dornbirn, Vorarlberg
BG/BRG 11 Geringergasse, Wien
BG/BRG 13 Wenzgasse, Wien
GRG 11 Gottschalkgasse, Wien
GRG 17 Parhamergymnasium, Wien
BG/BRG 13 Fichtnergasse, Wien
BRG 7 Kandlgasse, Wien
HTL Rosensteingasse, Wien
Wiedner Gymnasium, Wien
TGM - Technologisches Gewerbemuseum, Wien



„Jede Reise beginnt mit dem ersten Schritt“ - Dies gilt ganz besonders auch für erfolgreiche Karrieren in Wissenschaft und Forschung. Dabei ist der erste Schritt oft der herausforderndste. Daher hat das Bundesministerium für Wissenschaft und Forschung (BMWF) im Jahr 2007 ein unkonventionelles und in Europa einzigartiges Programm der wissenschaftlichen Nachwuchsförderung aus der Taufe gehoben: „Sparkling Science“ ermöglicht jungen Menschen bereits sehr früh hautnah Einblicke in die Welt der Wissenschaft und Forschung.

In den von „Sparkling Science“ geförderten Projekten sind Schülerinnen und Schüler als Juniorpartner in erfahrene Forschungsteams eingebunden. Sie arbeiten aktiv im Forschungsprozess mit und bringen eigene Fragestellungen, Denkanstöße und inhaltliche Beiträge ein. Die Schülerinnen und Schüler wirken an der Konzeption und Durchführung von Untersuchungen mit, führen Befragungen durch, erheben Daten, interpretieren diese gemeinsam mit den Wissenschaftlerinnen und Wissenschaftlern und stellen die Ergebnisse an Schulen, Universitäten und sogar bei wissenschaftlichen Tagungen vor.

Diese Zusammenarbeit von Forschung und Schule bringt für beide Seiten einen großen Mehrwert: Die Wissenschaft profitiert, weil die Jugendlichen innovative Ideen und erfrischende Beiträge einbringen, die dann in neue wissenschaftliche Erkenntnisse einfließen. Die Jugendlichen wiederum bekommen einen

einzigartigen Zugang zu neuen wissenschaftlichen Fragestellungen und erwerben Kompetenzen in den Bereichen Teamarbeit, Projektplanung und Projektpräsentation. Sorgfältig und eigenverantwortlich an komplexen Themenstellungen zu arbeiten und sich dabei auch mutig in Neuland vorzuwagen, sind dabei nicht nur entscheidende Basiskompetenzen für wissenschaftliches Arbeiten, sondern auch Schlüsselfertigkeiten in sämtlichen Berufsfeldern der modernen Arbeitswelt.

Eine der wichtigsten Grundregeln wissenschaftlichen Arbeitens besteht darin, Forschungsergebnisse zu publizieren und damit für andere Wissenschaftlerinnen und Wissenschaftler bzw. die Öffentlichkeit zugänglich zu machen. Mittlerweile liegen einige Publikationen in anerkannten wissenschaftlichen Fachzeitschriften vor, in denen an „Sparkling Science“-Projekten beteiligte Schülerinnen und Schüler als Co-Autorinnen und Co-Autoren vertreten sind.

Ein erster Schritt für das spätere erfolgreiche wissenschaftliche Publizieren sind mit Sicherheit die hier vorliegenden Abschlussarbeiten. Sie entstehen im Rahmen der Projekte von Schülerinnen, Schülern und Studierenden und bearbeiten eigenständig Teilbereiche des Forschungsprojektes. Und dies in beeindruckender Art und Weise. Das Bundesministerium für Wissenschaft und Forschung gibt daher eine eigene Publikationsreihe für jene Forschungsergebnisse heraus, die im Rahmen von Maturaprojekten sowie Bakkalaureats- und Masterarbeiten aus „Sparkling Science“ erarbeitet werden.

Ich gratuliere allen jungen Nachwuchsforscherinnen und Nachwuchsforschern zu diesen ersten Schritten und wünsche viel Freude und Erfolg auf dem weiteren Weg in Wissenschaft und Forschung.

Herzlich,

Dr. Karlheinz Töchterle
Bundesminister für Wissenschaft und
Forschung



Chemie ist, wo es raucht und stinkt!

Mit diesem Vorurteil ist leider nach wie vor die Wahrnehmung der Chemie in der breiten Öffentlichkeit verbunden. Und dies, obwohl wir uns die Annehmlichkeiten unserer modernen Gesellschaft ohne die massiven Beiträge der Chemie nicht mehr wirklich vorstellen können, denken wir doch nur an die Materialien unserer Smartphones und Laptops, die Kunstfasern unserer Funktionsportkleidung, die neue beschichtete Bratpfanne, die ganz leicht zu reinigen ist, oder auch an die Tablette, welche unlängst in kürzester Zeit den beginnenden Kopfschmerz vertrieben hat.

Das Projekt „Grüne Chemie“ ist angetreten, mit diesem Klischee über die umweltbelastende Chemie bereits bei Jugendlichen durch Aufklärung aufzuräumen. Moderne chemische Verfahren, insbesondere in den industrialisierten Nationen Europas, stehen heute im Einklang mit den ökologischen Anforderungen einer umweltbewussten Bevölkerung und laufende Forschungsarbeiten eröffnen stets weitere technologische Verbesserungen.

Im Rahmen von Sommerpraktika wird beim Projekt „Grüne Chemie“ bereits Schülerinnen und Schülern die Möglichkeit geboten, selbst in den Elfenbeinturm der Hochschulen und hinter die Vorhänge der universitären Forschung in diesem interdisziplinären Bereich zu blicken. Dabei können die Kandidatinnen und Kandidaten selbst Experimente durchführen und Teilbereiche von längerfristigen

Forschungsvorhaben gemeinsam mit und unter Anleitung von universitären Forscherinnen und Forschern bearbeiten. Die dabei gewonnen Erkenntnisse werden im nachfolgenden Schuljahr zu umfassenden Berichten und sogar Fachbereichsarbeiten ausgebaut.

Während der letzten drei Jahre konnten dabei über 60 Schülerinnen und Schüler von 17 Partnerschulen an derartigen Projekten innerhalb der Fakultät für Technische Chemie der TU Wien teilnehmen. Die Themenbereiche erstreckten sich dabei von erneuerbaren Rohstoffen und alternativer Energieerzeugung, über neue Materialien für Anwendungen in der Medizintechnik und Unterhaltungsindustrie, bis hin zu Studien zur Lebensmittelsicherheit. Eine Vielzahl von Würdigungspreisen dokumentiert die hohe Qualität der erbrachten Leistungen und als Betreuer konnte man sehr häufig den sprichwörtlichen Funken überspringen sehen.

Ich hoffe, dass wir mit unserer Initiative die Begeisterungsfähigkeit der nachfolgenden Jungforscherinnen- und Jungforschergeneration stimulieren konnten, vor allem um sich die jugendliche Neugierde zu erhalten und vermeintlich Bekanntes stets zu hinterfragen, um letztendlich zu Innovationen zu gelangen.

Es sind genau die Fragen unserer Schülerinnen und Schüler, die uns häufig am meisten herausgefordert haben, betrachteten sie doch viele Problemstellungen aus neuen Blickwinkeln und eröffneten damit unerwartete Perspektiven. Und was sie bereits jetzt erkannt haben, hoffen wir in Zukunft noch klarer der Allgemeinheit zu vermitteln: Die richtige Chemie stinkt nicht!

ao. Univ.Prof. DI Dr. Marko D. Mihovilovic
Technische Universität Wien
Institut für Angewandte Synthesechemie



Die HBLVA für chemische Industrie hat eine lange Tradition mit Projekten, Projektstudien und Diplomarbeiten gemeinsam mit Industriebetrieben, Gewerbebetrieben aber auch universitären Einrichtungen. Daher war uns die Einladung seitens des Instituts für angewandte Synthesechemie der Technischen Universität Wien sehr willkommen, an verschiedenen „Sparkling Science“-Projekten mitzuarbeiten. Konkret übernahm ich die schulische Betreuung der Arbeit „Synthese elektrolumineszenter Oligothiophene“.

Zwei interessierte und in organischer Synthese begabte Schülerinnen zu finden, war nicht allzu schwer. Auch die Vorgabe, die Arbeit komplett in englischer Sprache abzufassen, hat das Schülerinnen-Team nicht abgeschreckt, zumal hierzu tatkräftige Unterstützung seitens deren Englischlehrerin Dr. Barbara Gleiss angeboten wurde.

Durch dieses Projekt hatten die beiden Schülerinnen die Möglichkeit, ihr bisheriges organisch-chemisches Wissen enorm zu erweitern und auch praktisch umzusetzen. Umgekehrt hat sich auch gezeigt, dass praktische Arbeit nicht nur Spaß macht, sondern auch die Aufnahme theoretischen Wissens erleichtert.

Für Caterina Benigni und Aileen Opelt war die Projektarbeit eine interessante Erfahrung, die diesen mit vielen schönen und spannenden Augenblicken in Erinnerung bleiben wird. In Univ.Ass. DI Dr. Ernst Horkel fanden sie einen Projektbetreuer mit hohem fachlichem Know-

how, das er in erfrischender Art und Weise mit gut strukturiertem Zeit- und Arbeitsmanagement als auch freundlicher und aufmerksamer Mitarbeiterführung zu verbinden wusste.

Vergessen sollte auch nicht die Unterstützung durch die Herren Lumpi und Fruhmann werden, die den reibungslosen Ablauf der praktischen Arbeit am Institut gewährleisteten. Über diese vielen Augenblicke beruflicher Zusammenarbeit haben sich die beiden besonders gefreut.

Als Krönung ihrer Arbeit wurden Aileen Opelt und Caterina Benigni von Univ.Prof. DI Dr. Johannes Fröhlich im April 2010 nach Montpellier eingeladen, wo sie ihre Diplomarbeit auf der ECTN Annual Conference 2010 einem internationalen Publikum präsentieren durften. Nach ihren Eindrücken gefragt, sagte Frau Benigni unter anderem folgenden Satz: „Vor allem aber fühlte ich Freude und Stolz, den Wissens- und Forschungsstandort Wien mit der TU und der HBLVA Rosensteingasse repräsentieren zu können.“ Dem ist nichts mehr hinzuzufügen.

Aktuell sind wieder einige „Sparkling Science“-Projekte an unserer Schule gemeinsam mit der TU Wien in Arbeit und wir hoffen, dass diese Kooperationen zwischen Wissenschaft und Schule weiter geführt werden, da sie unter anderem ein Garant dafür sind, neue Talente zu entdecken.

AV DI Dr. Renate Tlustos-Ziegler
HBLVA für chemische Industrie, 1170 Wien

**„ES IST SCHWIERIGER, EINE VORGEFASSTE MEINUNG
ZU ZERTRÜMMERN ALS EIN ATOM.“**

- Albert Einstein (Physiker und Nobelpreisträger)



HBLVA für chemische Industrie

Höhere Lehranstalt für Chemie

Ausbildungsschwerpunkt Technische Chemie - Umwelttechnik



DIPLOMA THESIS

Synthesis of Electroluminescent Oligothiophenes

Performed during 2008/09 by:

Caterina Benigni 5YHCHT - 01

Aileen Opelt 5YHCHT - 05

Supervisors:

Dipl.-Ing. Dr. Renate Tlustos-Ziegler
(HBLVA 17)

Univ.-Ass. Dipl.-Ing. Dr.techn. Ernst
Horkel (TU Wien)

o. Univ.-Prof. Dipl.-Ing. Dr. techn.
Johannes FRÖHLICH (TU Wien)

Vienna, 28th May 2009

Performed in cooperation with the
Institute of Applied Synthetic Chemistry
(Vienna University of Technology)

A project of "**Sparkling Science**" from BMWF

Eidesstattliche Erklärung

Ich erkläre an Eides statt, dass ich die vorliegende Diplomarbeit selbstständig und ohne fremde Hilfe verfasst, andere als die angegebenen Quellen und Hilfsmittel nicht benutzt und die den benutzten Quellen wörtlich und inhaltlich entnommenen Stellen als solche erkenntlich gemacht habe.

Wien, am 28.Mai 2009

Verfasserinnen:

Caterina BENIGNI

Aileen OPELT

Abstract

This Diploma thesis deals with the synthesis of organic electroluminescent compounds which can be used in organic light emitting diodes (OLEDs). At the moment, research in the OLED-area is a very innovative field of activity with strong connections to the industry. OLEDs are mainly used for display manufacturing and offer a wide range of research possibilities.

The intention of the project was to optimize the synthetic pathway for four OLED-substances. Since the synthesis should be as inexpensive as possible, it was tried to start with low-cost substances and to reach the goal over several synthetic steps. The synthetic strategy was planned at the IAS / TU Vienna. The task was to investigate the different possible synthetic pathways experimentally, to find the best method while optimizing every step. Most of the reactions were performed according to instructions from literature, varying the amount of chemicals and the reaction conditions if necessary.

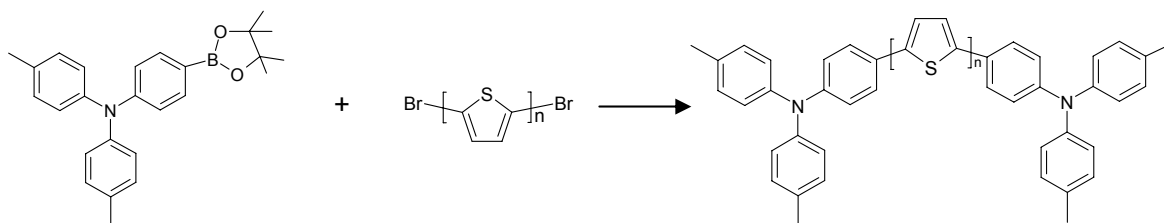

The OLED-substances themselves should be produced out of Cap-Boron (2-[4-[Bis(4-methylphenyl)amino]phenyl]-4,4,5,5-tetramethyl-1,3,2-dioxaborolane **11**) and one of four dibromo-oligothiophenes (n=1-4). These were produced by metalorganic reactions with n-BuLi or Suzuki coupling. Compound **11** was synthesised via a multi-step-reaction, starting with simple substances such as bromobenzene and toluene. These were modified by brominations, hydrogenations, metallorganic reactions and other reactions to, eventually, obtain **11**.

In spite of limited labour time (1 month for practical work), two of four target substances and three of four dibromothiophenes (last prestage) could be obtained.

Kurzfassung

Diese Diplomarbeit beschäftigt sich mit der Herstellung organischer elektrolumineszenter Verbindungen zur Verwendung in organischen Leuchtdioden (OLEDs). Das Gebiet der OLED-Forschung ist ein momentan äußerst innovatives Feld mit starkem Bezug zur Industrie. Sie finden vor allem Anwendung in der Herstellung von Displays und bieten ein breites Spektrum an Forschungsmöglichkeiten.

Das Projekt hatte zum Ziel den Syntheseweg für vier OLED-Substanzen zu optimieren. Da die Synthese möglichst kostengünstig gehalten werden sollte, wurde versucht den Syntheseweg mit billigen Substanzen zu beginnen und anschließend über mehrere Zwischenstufen die Zielsubstanzen zu erreichen. Die Planung dieses Syntheseweges wurde vom IAS an der TU Wien übernommen. Die Aufgabe bestand darin die verschiedenen Möglichkeiten experimentell durchzuführen, den besten Weg zu ermitteln und die Durchführung der einzelnen Syntheseschritte zu optimieren. Hierzu wurden die Reaktionen nach Vorschriften aus der Literatur durchgeführt und wenn nötig durch Variation des Ansatzes bzw. der Reaktionsbedingungen optimiert

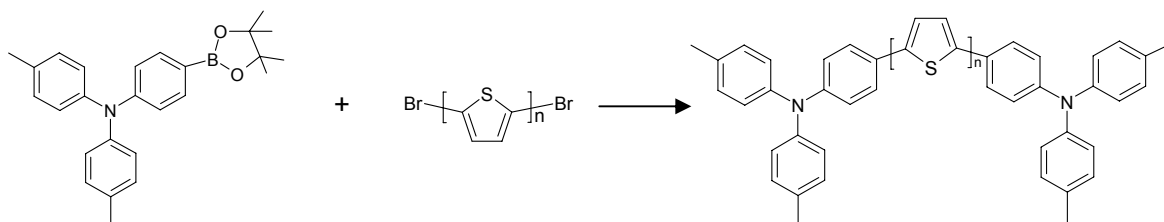

Die OLED-Substanzen sollten aus Cap-Boron (2-[4-[Bis(4-methylphenyl)amino]phenyl]-4,4,5,5-tetramethyl-1,3,2-dioxaborolane **11**) und einer von vier Dibromoligothiophenen ($n=1-4$) hergestellt werden. Diese wurden mittels metallorganischer Reaktionen mit $n\text{-BuLi}$ oder mit Suzuki-Kupplung hergestellt. Verbindung **11** wurde über eine Vielzahl von Zwischenstufen aus einfachen Substanzen wie Brombenzol oder Toluol hergestellt, welche durch Reaktionen wie unter anderem Bromierungen, Hydrierungen und metallorganischen Reaktionen modifiziert wurden.

Trotz beschränkter Arbeitszeit (1 Monat) konnten zwei von vier Zielsubstanzen und drei von vier Oligothiophenen (letzte Vorstufe) hergestellt werden.

Sparkling Science

This diploma thesis was performed in cooperation with the Sparkling Science Project.

The project offers the possibility to contribute to recent and ongoing research activities at the Vienna University of Technology in order to increase the pupils' interest for physical sciences, in general, and for chemistry, in particular. This requires a comprehensive program as offered by this consortium consisting of laboratory experiments, interpretation of data, compilation of reports and ultimate communication of results and background information. In addition, this initiative also includes teachers by offering a cooperative high level training for dedicated students as well as by providing material on state-of-the-art research topics for teaching purposes. In addition, this initiative aims at making new contacts, in particular with grammar schools, to increase the numbers of pupils interested in physical sciences; This should also provide a better understanding of educational perspectives at university level.

As one of the first programs of the last Sparkling Science call, the initiative „Green Chemistry @ Sparkling Science” was launched already in summer 2008 with an intensive training period at the Vienna University of Technology. A large diversity of research projects were offered to interested students, and hands-on experiments were conducted at the university campus during the summer. In the following study year compilation and interpretation of the obtained data was implemented resulting in the compilation of research reports and “Fachbereichsarbeiten”. [1]

Acknowledgements

At first, we want to thank everyone who organized this project.

Especially Prof. Dr. Bibiana Meixner, who found this very interesting topic for us and brought us in contact with Sparkling Science.

Additionally, we want to thank o.Univ. Prof. Dipl.-Ing. Dr. techn. Johannes FRÖHLICH, dean of the department for technical chemistry of the Technical University in Vienna, for providing the laboratory.

And AO. Univ.Prof. Dipl.Ing. Dr. techn. Marko Mihovilovic for organizing and administrating the Sparkling Science project at the TU Vienna.

Secondly, we want to thank our supervisors.

Dipl.-Ing. Dr. Renate Tlustos-Ziegler, who was our supervisor at the HBLVA 17 and always listened to our problems and questions, for her support and encouragement.

And Univ.-Ass. Dipl.-Ing. Dr.techn. Ernst Horkel, our supervisor at the TU Vienna. Very motivated, he was eager to improve our theoretical knowledge and to optimize our written work.

Thirdly, we want to thank all the others who made this project possible:

Daniel Lumpi, who was always there when he was needed, for his encouragement and helpfulness. He also provided a friendly and motivating working atmosphere.

We also want to thank Philipp Fruhmann for his organised working style and for providing all the chemicals and glassware we needed.

Finally, we would like to thank Prof. Gleiss, our very energetic and motivated English-teacher. Writing in English had been her idea and she checked our English grammar and spelling.

Contents

Abstract	3
Kurzfassung	4
Sparkling Science	5
Acknowledgements	6
Contents	7
Reaction scheme and goal	10
Theoretical part	13
1. OLED	14
1.1 Future aspects	14
1.2 What is an OLED?	15
1.3 Principle	15
1.4 Comparison to LCD	15
1.5 OLED design	16
1.6 Display types	17
1.7 Production process	18
2. NMR - Nuclear Magnetic Resonance	20
2.1 Basics	20
2.2 Chemical shift δ	21
2.3 Spin-spin coupling	22
2.4 Peak area	23
2.5 ^{13}C -spectra	23
2.6 The NMR-spectrometer	24
3. GC – Gas chromatography	25
3.1 Basics	25
3.2 Mobile phase	25
3.3 Separation columns	26
3.4 Packed Columns	26
3.5 Capillary columns	26
3.6 Liquid film	27
4.0 MS – Mass Spectrometry	29
4.1 Instruments	29
4.2 Ionization	30
4.3 Mass Analyzers	31
4.4 The mass spectrum	33
4.5 GC-MS	34

5. Suzuki coupling	35
5.1 Mechanism of the Suzuki Coupling	35
5.2 Transmetallation	36
5.3 Advantage of the Suzuki coupling	36
Special part	37
R01: Synthesis of 4-Bromonitrobenzene (2)	38
R02: Synthesis of 4-Bromoaniline (3)	40
R03: Synthesis of 4-Iodotoluene (6).....	41
R04: Synthesis of 4-Bromo-N,N-bis(4-methylphenyl)-benzenamine (7)	42
R05: Synthesis of Tris(1-methylethyl) boric acid ester (9)	43
R06: Synthesis of 4,4,5,5-Tetramethyl-2-(1-methylethoxy)- 1,3,2-dioxaborolane (10)	44
R07: Synthesis of 2-[4-[Bis(4-methylphenyl)amino]phenyl]-4,4,5,5-tetramethyl-1,3,2-dioxaborolane (11)	45
R08: Synthesis of 4,4,5,5-Tetramethyl-2-(2-thienyl)-1,3,2-dioxaborolane (15)	46
R09: Synthesis of 5,5'-Dibromo-2,2'-bithiophene (17)	47
R10: Synthesis of 19	48
19a 2,2':5',2":5",2"'-Quaterthiophene	48
19b 2,2':5',2"-Terthiophene	48
R11: Synthesis of 5,5"'-Dibromo-2,2':5',2":5",2"'-quaterthiophene (18)	49
R12: Synthesis of 20	50
20a 4,4'-(2,5-Thiophenediyl)bis[N,N-bis(4-methylphenyl)-benzenamine].....	50
20b 4,4'-[2,2'-Bithiophene]-5,5'-diylbis[N,N-bis(4-methylphenyl)-benzenamine].....	50
Experimental part	51
Analytical Equipment.....	52
Melting points	52
GC/MS measurements	52
NMR spectroscopy	52
R01: Synthesis of 4-bromonitrobenzene (2)	53
R02: Synthesis of 4-bromoaniline (3).....	54
R03: Synthesis of p-iodotoluene (6).....	55
R04: Synthesis of 4-Bromo-N,N-bis(4-methylphenyl)-benzenamine (7)	56
R05: Synthesis of Tris(1-methylethyl) boric acid ester (9)	57
R06: Synthesis of 4,4,5,5-Tetramethyl-2-(1-methylethoxy)- 1,3,2-dioxaborolane (10)	58
R07: Synthesis of 2-[4-[Bis(4-methylphenyl)amino]phenyl]-4,4,5,5-tetramethyl-1,3,2-dioxaborolane (11)	59
R08: Synthesis of 4,4,5,5-Tetramethyl-2-(2-thienyl)-1,3,2-dioxaborolane (15)	60
R09: Synthesis of 5,5'-Dibromo-2,2'-bithiophene (17)	61

R10: Synthesis of 19	62
19a 2,2':5',2"':5",2"'-Quaterthiophene	62
19b 2,2':5',2"-Terthiophene	63
R11: Synthesis of 5,5"'-Dibromo-2,2':5',2"':5",2"'-quaterthiophene (18)	64
R12: Synthesis of 20	65
20a 4,4'-(2,5-Thiophenediyl)bis[N,N-bis(4-methylphenyl)-benzenamine].....	65
20b 4,4'-[2,2'-Bithiophene]-5,5'-diylbis[N,N-bis(4-methylphenyl)-benzenamine].....	66
Summary.....	67
Appendix	68
¹ H NMRs of target substances	69
¹³ C NMRs of target substances.....	70
List of abbreviations	71
Reagents.....	72
Apparatus.....	73
References.....	74

Reaction scheme and goal

The **goal** was to optimize the synthetic pathway for four electroluminescent substances (**20**), which should be usable in OLEDs.

In this **reaction scheme**, syntheses that were planned but not performed due to limited labour time are marked grey.

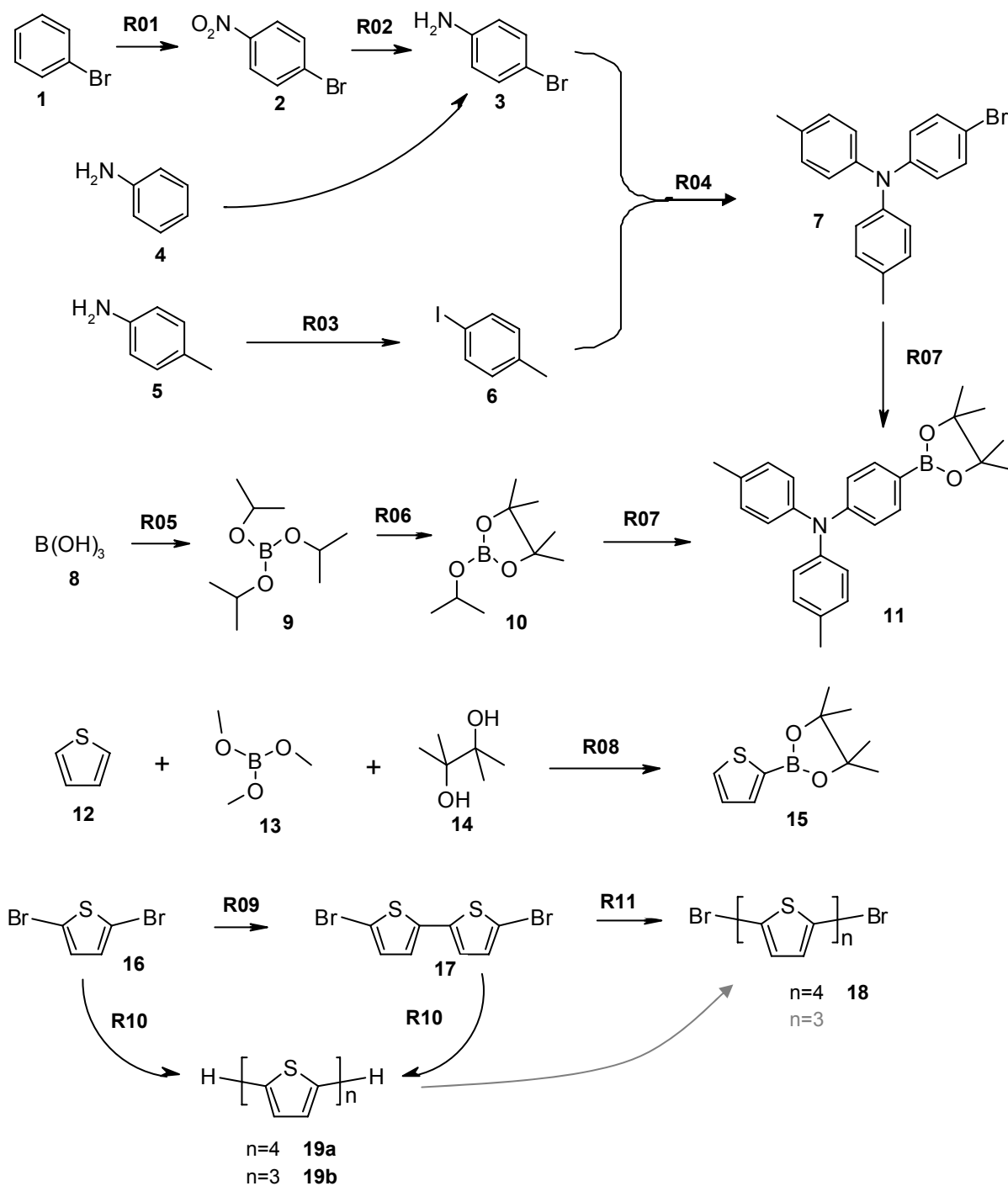

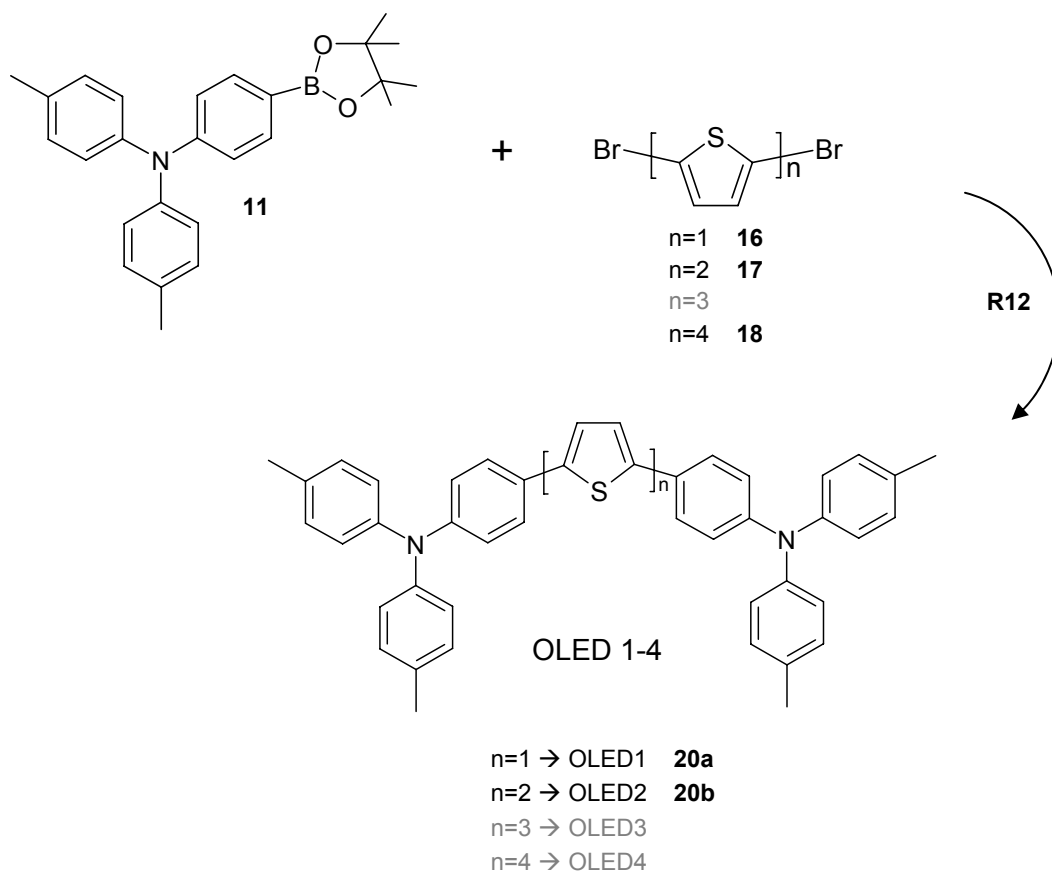

Theoretical part

1. OLED

1.1 Future aspects

Over the last few years international companies have started to invest in research and development of OLEDs. They have a variety of practical usages and are used in a wide field of products, which are offered on the communication market. Step by step, mobile phones and MP3-players with powerful und multicoloured OLED-displays have been developed. The additional usages of OLEDs gave way to the development and implementation of multi-usage software, as well as video-communication. Games, photographs and video-phoning profit from the high quality of colours and the online performance. So it is no surprise that high expectations for the TV-market have emerged. But these hopes will not get fulfilled over the next years, because OLEDs are rather sensible against oxygen and atmospheric moisture. So development and production of TV sets are thwarted by high technical problems, which leads to high costs. For the public market there is still some time to wait for more positive information. But it is sure that all the different possibilities of OLEDs will lead to great changes and developments in economic and scientific areas.

The most important OLED-using companies are Kodak (this company was the first which did research in this area), Sony (recently produced the first OLED-TV), Phillips (mobile phone displays and OLEDs as light source) and Nokia (mobile phone displays). At the moment, there are also the first pure OLED-companies, represented by the OLED Association.

As already mentioned above, OLEDs are mainly used in displays of mobile phones and Game Boys. The first OLED-TVs are already on the market, mainly in Japan, but too expensive for the average customer. Specialists expect OLEDs to completely replace LCDs in display technology but displays are not the only possible use of OLEDs. OLEDs can also be used as light sources and the first of these are expected to be available in three to five years, although only for decoration. Since there are already many different kinds of cheap bulbs available, the expensive OLEDs will not replace them but they will be used as decoration such as shining wallpaper or colour-changing curtains. The most important key to OLED's success is to reduce the high production costs, which is the main target of OLED-research at the moment. [2], [3], [4]

1.2 What is an OLED?

The abbreviation OLED stands for **O**rganic **L**ight **E**mitting **D**iode, which means that this is a LED that uses an organic semi-conductive compound instead of an inorganic semiconductor to emit light when voltage is applied. The colour depends on the used compound. In the simplest case an OLED consists of two electrodes and the organic substance inbetween. The light passes through the transparent anode made of indium tin oxide (ITO). OLEDs are particularly suited for applications in flat panel displays due to their colours and high luminescence coupled with low driving voltage. There are two categories of OLEDs, namely PLEDs (made of polymers) and SMOLEDs (made of small molecules). [5], [6]

1.3 Principle

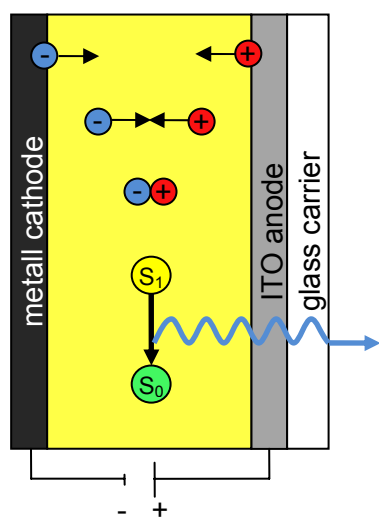

Fig. 1 single-layer-OLED [8]

When sufficient voltage is applied, negative (electrons) and positive (holes) charges start to move through the organic semiconducting material to the counter electrode. If a positive and a negative charge combine they form a so-called “exciton” (uncharged excited electron-hole-pair, state S_1). The exciton falls back to ground state (S_0) by emitting light. This process is called **electroluminescence**. [8]

For electroluminescence it is important to achieve an exciton in an appropriate excited state. This state is defined by the electron spin, which is the rotation of an electron. If an electron and a hole meet in the emissive layer there are four possible spin combinations. One of these combinations

is a so-called “singlet”, each of the other three combinations is a “triplet”. This means that singlet and triplet state appear in the ratio 1:3. Only a singlet emits light in the visible range. Therefore just one out of four excitons give light, the others emit their energy as heat. Hence, OLEDs, like normal bulbs, use most of the energy (75%) to create warmth instead of light. [6]

1.4 Comparison to LCD

The most important competitor of OLED-displays are LCDs (liquid crystal displays), which consist of a backlight, two polarisers and layer of LCs between the polarisers. The amount of light that passes through the device is determined by the LCs alignment. It is believed that one day OLEDs will take the place that LCs have now. Therefore, the advantages and disadvantages of OLEDs will be explained and compared to LCs.

Advantages:

Since OLEDs themselves shine, they do not need a backlight and consequently they need less power and can be thinner. Furthermore, they have a greater range of colour, higher brightness (LCDs require polarizers which filter out light), stronger contrast and a better viewing angle (pixel colour remains unchanged even at a 90° viewing angle). OLEDs also work in a wide range of temperature and have low weight.

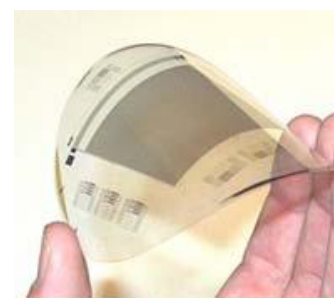

Fig. 2 Flexible AMOLED [9]

Additionally, it could be possible to print OLED-displays, which allows producing them on lower costs. These displays can be flexible when a flexible substrate (like PET) is used and they are able to show a true black by switching off a pixel while a LCD uses a backlight and therefore can't show a real black.

Disadvantages:

OLEDs are still in the developing phase so there are some unsolved problems. One problem is the low efficiency of the transport layers (see 1.5 OLED design). Another problem is the short lifetime of blue OLEDs. Red and green OLEDs already have a lifetime of more than 10,000 hours while the blue ones last approximately 2,000 hours. This does not only limit the overall lifetime of the display but also causes a colour shift which has to be automatically corrected by the device. Moreover, the emissive substance loses its luminosity if it comes in contact with water or oxygen, so it has to be impermeably sealed. Water is especially hazardous since it reacts with the low work cathode. [5], [6], [9], [10]

1.5 OLED design

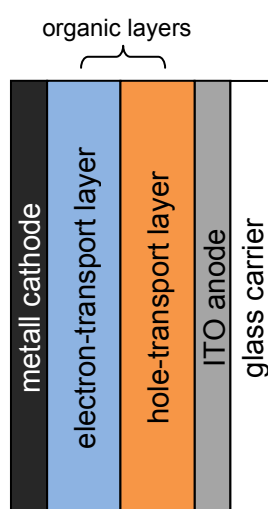

Fig. 3 two-layer-OLED

As mentioned above, the simplest case of an OLED has one layer of organic substance, but the simplest way is in most cases not the best. A better way of building OLEDs are **two-layer OLEDs** which consist of two layers of organic material (a hole-carrier and an electron-carrier). The recombination of electron and hole is most effective if there is a high concentration of the two partners. While the concentration is low, most charge carriers pass through the organic material without recombination and discharge at the counter electrode. An effective approach to solve this problem is an energy barrier within the organic layer (a result from the boundary of the organic phases). This blocks the charge carriers and causes an increase of the local concentration.

Multi-layer OLEDs have more than two transport layers and one "emissive layer" (the layer designed to emit light) in the middle. With this design the energy barrier between the anode

and the emissive layer is distributed over several smaller energy barriers between the different organic layers. These small barriers can be crossed more easily than a big one. The choice of the right thickness and energy level of the layers is most important because these parameters define if the recombination area is located properly, namely in the emissive layer. Additionally, like in the two-layer model, one type of carrier is blocked by the opposite transport layer, which increases the concentration and enhances the recombination efficiency. [5], [8], [9]

1.6 Display types

OLED displays can be solid or flexible, variable in size, but from a technical point of view, there are just two types of displays namely active and passive matrix displays.

Passive matrix displays have electrodes that consist of an array of small adjoining conductive paths. The conductive paths of cathode and anode describe a 90° angle. Each cross point between anode and cathode path forms a pixel. These pixels are activated by applying voltage to the right columns and rows.

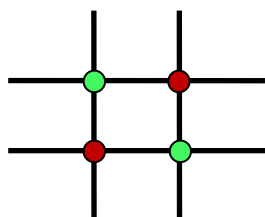

Fig. 4

So what if you want to activate two diagonal pixels as shown in Fig. 4?

To activate the pixels marked with a green point, it is necessary to apply voltage to both rows and columns, but this would also cause the other cross points (red points) to shine and a wrong image would be obtained. Therefore, passive matrix displays build images row by row

which means that voltage is applied to the first row and the correct pixels are chosen by applying voltage to the proper columns. Then voltage is removed from the first row and applied to the second row instead, etc. After reaching the last row the process starts again with the first row. This cycle has to be very fast so that humans, compare the single pictures of films, can just see the whole image (usually 60 Hz, which means that the cycle is repeated 60 times per second). Due to the facts that no pixel shines for a whole cycle and that what we see is just the average, pixels have to be extremely bright.

Because of losses in the conductive paths the display size is limited to approximately 5 cm of screen size.

In an **active matrix display** each pixel is controlled separately by a thin film transistor (TFT) which is nearly similar to those used for LCDs. For an OLED display the TFT has to be capable of handling much higher currents. The anode of the pixel is built directly onto the TFT circuit. Each TFT continuously controls the current that flows to the pixels and consequently controls the brightness, too. These displays provide the same performance as their passive matrix counterparts but have lower energy consumption and an unlimited display size. [5], [8], [9]

1.7 Production process

At the moment, there are two main production processes. SMOLEDs are usually produced by vacuum deposition; PLEDs are mainly produced by inkjet printing.

Vacuum deposition / SMOLEDs

Nowadays, SMOLEDs are mainly manufactured with vacuum deposition techniques. Normally this is done on a glass substrate which leads to inflexible displays. SMOLEDs have advantages in some device-performance aspects, in particular when it comes to device lifetime. However, the required sophisticated instruments lead to relatively high production costs. There are many different techniques for vacuum deposition, but in this work only the newest will be explained. [5]

Shortly described, vacuum thermal evaporation means that the substance is evaporated by heating and then deposited on the cold substrate by condensation. To avoid reaction between vapour and gas this is done by 10^{-6} to 10^{-5} Torr.

For the use in organic electronics the OVPD (Organic Vapor Phase Deposition) was developed. As shown in Fig. 5, evaporation of the organic material occurs in individual quartz pipes. A precise amount of carrier gas, for example nitrogen, is added into each quartz pipe to pick up the organic molecules. The

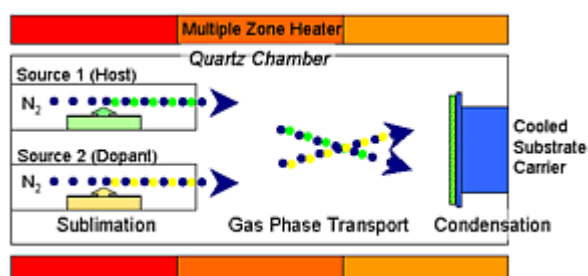

Fig. 5 OVPD principle [5]

organic molecules are transported by the carrier gas into the hot wall deposition chamber and are uniformly mixed if two organic materials or more are evaporated simultaneously. Finally the organic molecules in the gas phase condense on the cooled substrate. One consequence of this technique is that no unintended deposition of expensive organic molecules occurs in the hot wall deposition chamber itself, the deposition is mainly on the substrate. This enables high material utilization.

Using a carrier gas in OVPD enables the deposition of organic materials at a controlled pressure of 10^{-3} – 10 torr. Thus, the OVPD module does not have to be pumped down to high vacuum conditions, as in vacuum thermal evaporation methods, which consequently increases the uptime of the OVPD deposition system. Also, the continuous purge of carrier gas in OVPD prevents any contamination of parasitic surfaces, which increases the reproducibility of the deposited organic film quality. [7]

Multicolour displays are produced by using fine metal shadow masks with features of 50-100 μm (pixel size). This shadow masks are thin metal sheets with holes. The materials are deposited through the gas phase onto the substrate which is covered by the shadow mask, then the mask is removed and a pixel pattern is obtained. The problem of this method is that

during continuous use of the mask, material accumulates on the mask and reduces the resolution and accuracy of deposition. So the masks have to be cleaned or even replaced relatively often. [5]

Inkjet printing / PLED

PLEDs are normally produced by wet processing, mainly by inkjet printing. Solution-based processing techniques can be easy and cheap, which makes them more attractive than vacuum techniques. Inkjet printing is capable of placing small amounts of solution (droplets) with high accuracy and reproducibility. For multilayer OLEDs it is important that previously deposited layers are absolutely resistant against the solvent used to deposit the subsequent layer. [5]

2. NMR - Nuclear Magnetic Resonance

NMR is a spectroscopy-method for structural elucidation of organic compounds, which uses the magnetic properties of nuclei.

2.1 Basics

Every charge possesses an electric field and moving electric fields produce magnetic fields. The atom consists of protons (positive charge), neutrons (no charge) and electrons (negative charge). Electrons possess two magnetic fields, one from their spinning motion and one from their circulation around the nucleus. The first will not be further discussed since, in general, there are electron pairs, which have always opposite spins. The second magnetic field is important and is described in chapter 2.2 in greater detail. The atomic nucleus can also possess a magnetic field when it spins around the nuclear axis (spinning proton = moving charge). The spinning motion of a nucleus is determined by the spin quantum number I . There are three different cases:

Mass number	Atomic number	Nuclear spin I
Odd	Even or odd	Half-integer ($1/2, 3/2, \dots$)
Even	Even	0
Even	Odd	Integer ($1, 2, \dots$)

Table 1 Nuclear properties

In the second case the nucleus does not spin and is therefore a non-magnetic nucleus which cannot be studied with NMR. Of special interest are nuclei with $I=1/2$, because all other magnetic nuclei ($I>1/2$) have a non-uniform charge distribution over the nuclear surface which leads to broadened peaks in their NMR spectra.

When a magnetic nucleus is placed in a static magnetic field B_0 , it can orient itself with respect to the magnetic field in $2I+1$ ways. Hydrogen nuclei have a spin quantum number $I = 1/2$ and consequently, they have two possible orientations, namely parallel or antiparallel to the magnetic field. The parallel state has a lower and more stable energy level than the antiparallel state. Hence, it is possible to excite the nucleus from the lower to the higher energy state by using electromagnetic radiation with the proper frequency. [12], [13], [14]

In reality, the nuclear axis is not really parallel to the magnetic field. The nuclear spinning axis describes an angle θ with respect to the magnetic field. The frequency of this precession motion is called Larmor frequency ($\omega_L = \gamma B_0$) and depends on the magnetic fields strength and the magnetogyric ratio γ , which is specific to each atom. It is also the frequency needed to excite the nucleus. [11], [12], [13], [14]

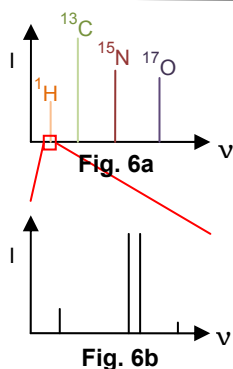

This means that different atoms absorb at different frequencies (see Fig. 6a). For measurement either the frequency can be kept constant and the magnetic field is altered or vice versa.

In reality, not all atoms of one kind in a molecule absorb at exactly the same frequency, there are slight differences due to the different chemical surroundings. So if a ¹H-spectrum is measured, peaks in the area of ¹H absorption are measured (see Fig. 6b). [12], [14]

2.2 Chemical shift δ

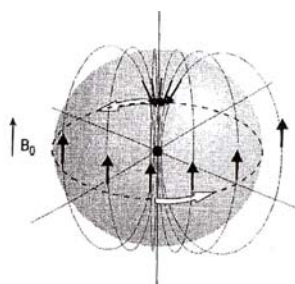

Fig. 7 Shielding [12]

As already mentioned above, not all ¹H-atoms in a ¹H-spectra absorb at the same frequency, this is because they do not have the same chemical surroundings. Not only the protons of the nucleus, but also the electrons in the atom shells, which are moving charges, are magnetic. In an external magnetic field they circulate around the nucleus, producing their own magnetic field which opposes the applied field (see Fig. 7). So the effective magnetic field for the

nucleus is smaller than the applied field. This effect is called shielding, and consequently, the Larmor frequency is decreased, too. For a particular nucleus in a molecule the degree of shielding depends on the density of electrons circulating around that nucleus. For example, in CH₃Cl: Cl is more electronegative so it draws electrons and decreases the electron density around the protons. This means that the proton is less shielded and experiences a higher magnetic field which causes a higher Larmor frequency.

The difference between the peak position of a particular nucleus and a reference (for ¹H- and ¹³C-spectra usually TMS = tetramethylsilane) is called the chemical shift δ and is in the Hz-region, while the applied frequency is in the MHz-region (radiofrequency). Therefore δ is normally expressed in the dimensionless unit ppm (parts per million) of the applied frequency.

$$\delta = \frac{\nu_{\text{sample}}[\text{Hz}] - \nu_{\text{reference}}[\text{Hz}]}{\text{Applied frequency}[\text{MHz}]}$$

formula 1 The chemical shift [12]

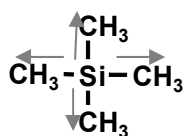

Fig. 8 TMS

TMS is defined as 0 ppm for ¹H-spectra because Si has a strong +I-effect (pushes electrons away) and therefore, the atoms of the CH₃-groups are especially well-shielded, so in most cases TMS absorbs at the lowest frequency. In NMR-spectra the chemical shift increases from right to left, therefore, the lowest chemical shift, and the lowest frequency/best shielding is on the right end of the spectrum. [12], [13], [14]

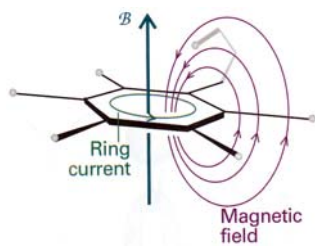

Fig. 9 Shielding in aromatic systems [13]

Some shifts cannot be explained only by the $\pm I$ -effect of neighbouring groups, but by anisotropy. Exemplary, aromatic systems are a special case: The applied magnetic field causes the electrons to circulate around the ring and so creates a magnetic field. This field deshields protons in the plane, but shields all other protons. [13]

2.3 Spin-spin coupling

Hydrogen atoms in a molecule interact with each other using the bonding electron. These interactions are visible with NMR as long as the atoms are magnetically different. In general, hydrogen atoms of $-CH_3$ or $-CH_2-$ are similar since the σ -bond is rotatable (it is impossible to differ between the H-atoms of such groups).

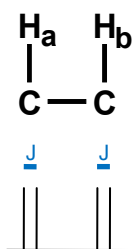

Fig. 10

Fig. 10: H_b has two possible orientations, antiparallel and parallel, which have the same statistical probability. Therefore, the peak of H_a is split into two peaks with equal intensity. These peaks are separated by the coupling constant J and the centre between the two peaks is δ . H_a affects H_b in the same way.

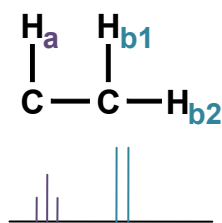

Fig. 11

Fig. 11: In this sample H_a has two equal neighbours. Both of them have two possible orientations, so there should be four ways of orientation (see Table 2). Since the second and the third case are energetically identical, there are just three possibilities for orientation of H_{b1} and H_{b2} : both \uparrow (parallel), both \downarrow (antiparallel), or one \uparrow and one \downarrow . So the signal of H_a is separated into three peaks, where the centre peak is twice as high as the others (due to the fact that there are two ways for $\uparrow\downarrow$ but just one for $\uparrow\uparrow$ or $\downarrow\downarrow$). Both, H_{b1} and H_{b2} , are equal, so they act as one atom when it comes to their own signal. There is one signal for both H_b which is split into two by H_a .

H_{b1}	H_{b2}
\uparrow	\uparrow
\downarrow	\downarrow
\uparrow	\downarrow

Table 2 orientations

In other words, an H-atom has $n+1$ peaks, where n is the number of magnetically equal neighbouring H-atoms, and the intensity of these peaks can be described with Pascal's triangle (see Table 3).

n	Relative peak intensities	Multiplicity
0	1	singlet s
1	1 1	doublet d
2	1 2 1	triplet t
3	1 3 3 1	quartet q

Table 3 Pascal's triangle

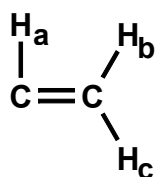

Fig. 13

In Fig. 13 H_a is coupled with two different H-atoms since double bonds are not rotatable. In a case like this both atoms split the signal of H_a into two signals (see Fig. 12) so a spectrum with four equal peaks can be obtained, which is not a quartet but a doublet of doublet (dd).

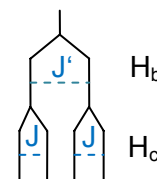

Fig. 12

With J further structural information can be obtained since J is specific for certain bonds like the ortho-, meta- and para-bond in aromatic compounds (see table 4) or E/Z-double bonds (see table 5).

J_{ortho}	= 6-10 Hz
J_{meta}	= 1-3 Hz
J_{para}	= 0-1 Hz

Table 4 J of aromatic 1H

J_E	= ~15 Hz
J_Z	= ~10 Hz

Table 5 J of double bonds

[12], [13], [14]

2.4 Peak area

The peak area of every peak that belongs to magnetically identical 1H -atoms is calculated by integration. This area is proportional to the relative number of these 1H -atoms. In Fig. 11 there is one H_a -atom and two equal H_b -atoms therefore the peak area of all three peaks (triplet) belonging to H_a has to be half the peak area of both peaks (doublet) of H_b . [12]

2.5 ^{13}C -spectra

Until now only 1H -spectra have been discussed, but since there are a lot more measurable nuclei, other spectra are of interest, as well. Having also a spin quantum number $I=1/2$, ^{13}C is also measured very frequently. Since ^{13}C has a natural abundance of only 1.1 per cent, the appearance of ^{13}C - ^{13}C -coupling is extremely unlikely because it is not probable that there are two neighbouring ^{13}C -atoms in one molecule. On the contrary, there are many 1H -atoms present in nearly every molecule with which ^{13}C -atoms can couple. Therefore, a very complex spectrum would be obtained. To avoid this, the technique of broadband spin

decoupling is used, which means that the protons in the molecule are saturated by irradiating them with a radiofrequency pulse. Hence, every ^{13}C -atom causes just one peak. This enhances sensitivity since the signal intensity is concentrated into one peak instead of being distributed into several split peaks. Furthermore, the intensity can be increased by the nuclear Overhauser effect for as much as 200 %. ^{13}C -spectra are often used complementary to ^1H -spektra.

The peak areas of ^{13}C spectra are not necessarily proportional to the relative amount of ^{13}C -atoms. [12], [14]

2.6 The NMR-spectrometer

For NMR measurements an appropriate source of electromagnetic radiation in the radiofrequency region and a magnet are needed.

Early instruments had a fixed frequency and a variable magnetic field, nowadays it is the other way round. Usually NMR-spectrometers have superconductive magnets which are capable of producing magnetic fields with more than 10 T. These magnets are electromagnets without resistance and therefore, an induced current flows endlessly through the coil. To remain superconductive, it is necessary to cool these magnets to liquid helium temperature. Thus, the coils are usually cooled with liquid helium which again is cooled with liquid nitrogen.

Additionally, earlier NMR spectrometers were continuous spectrometers, which means that absorbance was measured at every wavelength (or field strength) as in other spectrometric techniques. This technique has low sensitivity, poor signal-to-noise ratio and is rather time-consuming. So a new type of NMR spectrometer was developed, the Fourier transform NMR spectrometer (FT-NMR).

This technique uses short pulses of radiofrequency to excite the entire NMR spectrum simultaneously, then the radiation that is emitted from nuclei when returning to equilibrium is measured. The obtained intensity vs. time signal must be Fourier transformed to achieve a normal intensity vs. frequency spectrum.

The sample is usually dissolved in a solvent which should not contain ^1H in case of an ^1H -spectrum. In general, deuterated solvents are used. Nowadays the reference substance TMS is no longer used even if it is still defined as zero in the spectrum. The solvent peak is used for calibration, instead (for example: CDCl_3 has got a peak at 7.26). [11], [12], [15]

3. GC – Gas chromatography

3.1 Basics

Gas chromatography is an analytical method where the mobile phase is gaseous. The analyt interacts with the stationary phase either by distribution (the stationary phase is a liquid film - gas liquid chromatography) or adsorption (the stationary phase is solid - gas solid chromatography).

The carrier gas (mobile phase) flows through the GC and transports the injected sample through the column after vaporization.

Every single compound is temporarily dissolved in the liquid stationary phase or adsorbed on the surface of the solid stationary phase. Substances with high affinity to the stationary phase are more retarded than such with low affinity to the stationary phase. Therefore they pass the column with longer retention times. As a rule, polar substances have a high affinity to polar stationary phases and non-polar substances to non-polar stationary phases. [16], [17]

3.2 Mobile phase

The carrier gas is an inert gas which transports the sample through the column. This means that the mobile phase does not influence the elution behaviour of the substances, but differing the flow rate causes extreme changes.

Traditional gases in the gas chromatography are

- hydrogen, H_2
- helium, He
- nitrogen, N_2

The gas has to be a highly pure, free of oxygen ($<0,01\text{ppm}$) (because it attacks the stationary phase), dry (because water splits the stationary phase hydrolytically) and free of hydrocarbon (because it increases the detector noise).

The flow of the carrier gas regulates the speed of the material transport through the separation column and causes two contradictory effects:

- exchange efficiency

The efficiency of the exchange of materials between the mobile phase and the stationary phase is high by a low flow, which causes a good separation.

- diffusion

A low flow causes high diffusion and therefore wide peaks are received in the chromatogram.

The flow has to be optimized between these two processes to get an adequate separation while keeping the necessary time for the analysis as short as possible. [16]

3.3 Separation columns

The stationary phase in the column separates the sample in its components.

In the gas chromatography there are two kinds of columns:

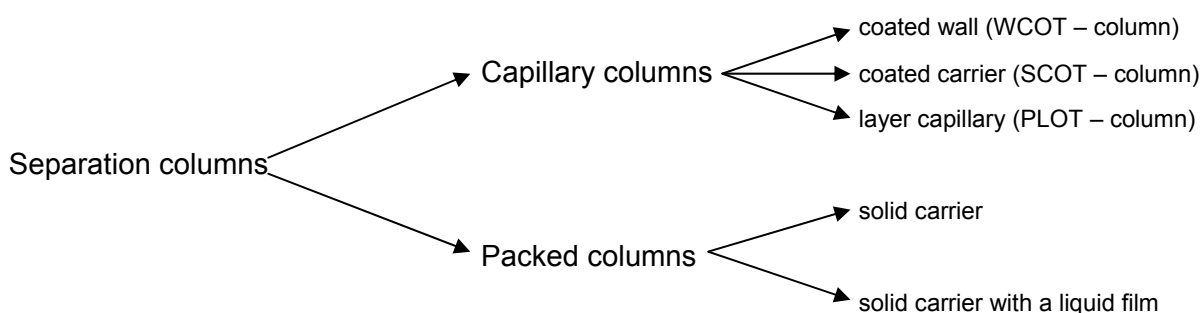

The loadability of a column is important for the amount of the sample which can be separated. Important is that the sample is separated in the column without any overloading charge (fronting or tailing).

The loadability depends on the constitution of the stationary phase and the dimension of the column: inside diameter, film thickness, length and the speed of the carrier gas. [16]

3.4 Packed Columns

For preparative separations the big amount of the stationary phase in the column is accounted. Thereby combinations can be separated because in capillary columns they elute with the hold – up time or a little bit later. [17]

3.5 Capillary columns

In gas chromatography there are three types of columns.

- PLOT – column (porous layer open tubular column)
- SCOT – column (support coated open tubular column)
- WCOT – column (wall coated open tubular column)

PLOT – column:

The solid stationary phase is provided on the wall of the capillary. The amount of the stationary phase is high for analytes which are not able to be separated on a liquid stationary phase (e.g.: permanent gases, short chain hydrocarbons). They are ideal for gas – solid – adsorption chromatography.

SCOT – column:

The stationary phase is a liquid film which is provided on a solid carrier on the wall of the capillary. The amount of the stationary phase is higher than by capillaries which have a coated wall. The separation of well volatile substances is better with SCOT – columns because on PLOT – columns the substances are being hold off. They are ideal for gas – liquid – distribution chromatography.

WCOT – column:

The stationary phase is a thin liquid film on the inner surface of the wall of the capillary. They have the biggest separation efficiency and so they are used for the trace analytic. Low sample volumes are taken for the separation. They are ideal for gas – liquid – distribution chromatography.

The type of the stationary phase (its polarity) decides about the retention of the analyte. It points the sum of some properties (charge distribution in the molecule, dipole moment) of the column and is measured empirically (with the retention of the test substances).

Test substances are chosen which have different chemical interactions with the stationary phase. [16]

3.6 Liquid film

The liquid film (the real stationary phase) on the carrier material has to be appropriate for different kinds of requirements:

- the analyte has to interact with the stationary phase
- the stationary phase has to have different kind of equilibrium coefficient for the analyte
- has to have a low volatility and viscosity
- has to have a thermal stability
- chemically inert

The polarity of the stationary phase must correspond to the analyte. If this is the case the compounds of the sample are separated according to the boiling point.

For every stationary phase a minimum and a maximum working temperature are denoted where the polymers change their chemical structure (degree of cross linking, crack up) or the interaction of the sample molecules are too low.

To stabilize the stationary phase in the column, a cross linking of the polymer is used (immobilization) or the polymer is bonded on the surface of the wall of the capillary. Cross linking reduces column bleeding and the stationary phase can be used longer. [16]

4.0 MS – Mass Spectrometry

Mass spectrometry is an important technique for the structural identification of unknown compounds. This method has two significant advantages over other spectroscopic methods. Firstly, it has a much higher sensitivity and requires the smallest amount of sample. Secondly, it is the most convenient method that can be used to determine the molecular formula of an unknown compound. [18]

4.1 Instruments

A mass spectrometer consists of the following units:

1. Inlet System

The sample is transferred into a mass spectrometer through an inlet system..

2. Ionization and acceleration chamber

An ionization and acceleration chamber is also known as an ion source in which molecules are ionized to form ions.

3. Mass analyzer

A mass analyzer, the key part of a mass spectrometer, differentiates ions according to their mass-to-charge ratios. As each type of mass analyzer has its own principle, function and application area, we will deal with various mass analyzers.

4. Detector

A detector converts ions to a recordable signal.

5. Computer and data system

A computer controls all processes of a mass spectrometer, including data accumulation, processing and printing, as well as spectrum retrieval. Elemental compositions of molecular ions and important fragment ions can be found by the computer of a high resolution mass spectrometer.

6. Vacuum system

A vacuum system provides the vacuum necessary for the ion source and the mass analyzer. The level of vacuum needed varies with the type of mass analyzer. [18]

4.2 Ionization

4.2.1 Electron Impact Ionization, EI

Electron Impact Ionization used to be called electron impact and now it is known as electron impact ionization or electron ionization. EI is the most widely used and highly developed method of ionization. If electrons are accelerated, they have a wavelength of the order of magnitude of the size of a molecule. When the wave passes through or near a molecule, the wave can be decomposed into a series of waves, one of which has the same phase as that of an electron of the molecule to be analyzed. Thus the electron will be expelled so that the molecule will become a positive ion.

In high vacuum, the interaction between the electrons and molecules leaves molecular ions with so much energy that most of them break to form smaller ions. This process is called fragmentation and the smaller ions “fragment ions”.

The absolute majority of ions formed by EI are single-charged ions whose mass-to-charge values are numerically equal to their mass values.

EI occurs in an ion source. Sample molecules in the gaseous phase enter the ion source in a high vacuum through a pinhole. A hot cathode emits electrons, which are accelerated and collide with sample molecules. A spiral trace of electrons, which is formed by an auxiliary magnetic field, enhances the probability of collisions between sample molecules and electrons.

The resulting ion beam is drawn out at an orthogonal angle with respect to the direction of the electron beam by a high acceleration voltage.

1. It produces reproducible mass spectra that can easily be used for mass spectral retrieval in a data system.
2. The mass spectra produced by EI contain many peaks of fragment ions (in a broad sense). This is very useful for Structure elucidation of unknown compounds.
3. EI is the most common ionization technique.

The disadvantage of EI is generally a low intensity of the molecular ion peaks. Sometimes, there is no molecular ion peak when samples to be analyzed are non-volatile or unstable to heat.

If the electron energy is decreased, the intensity of the molecular ion peak in an EI spectrum increases while intensities of all other peaks decrease. Other ionization techniques, which use lower energy and are termed “soft ionization”, are used to obtain molecular ion information. [18]

4.2.2 Chemical Ionization, CI

In CI, sample molecules are ionized through chemical reactions, hence its name. In EI, the ionization takes place in vacuum of about $1.2 \cdot 10^{-4}$ Pa while in CI, the ionization takes place in vacuum of about $1.3 \cdot 10^2$ Pa in presence of the reagent gas. As molecules of the reagent gas are in an overwhelming majority compared with sample molecules, they are ionized by energized electrons, and then a series of complicated chemical reactions take place. For a long time CI used to produce only positive ions. Later, CI in the negative ion mode has been developed. CI produces quasi-molecular ions.

The quasi-molecular ion produced by CI has a small amount of extra energy. CI produces few fragment ion peaks. [18]

4.3 Mass Analyzers

The mass analyzer is the key part of a mass spectrometer. Mass spectrometers are classified according to their type of mass analyzer.

4.3.1 Fourier Transform Mass Spectrometer

When there are several types of ions with different m/z -ratios then each type rotates with its own frequency when placed in a magnetic field between two parallel plates of a capacitor. An oscillating potential is applied to the plates. If the frequency is equal to the frequency of an ion, the ion is excited as it absorbs energy from the oscillating electric field and thereby the radius of the ion orbit increases, resulting in a spiral path as shown in Fig. 14.

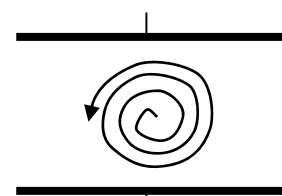

Fig. 14 FT-MS

Setting a magnetic field strength, a mass spectrum can be recorded by gradually changing the exciting frequency to excite the ions according to the order of mass-to-charge ratios. This means that all ions are detected in turns. In order to detect all ions at once, all ions are excited simultaneously. Each ion induces a signal in the plates, which has to be Fourier transformed. [18]

4.3.2 Quadrupole Mass Analyzers

A quadrupole mass analyzer (see Fig. 15) is also called a quadrupole mass filter, which consists of four parallel rod electrodes, hence its name. The opposite two electrodes are of equipotential. The two pairs of electrodes have opposite potentials.

These electrodes produce a magnetic field which influences the path of the ions. Only ions with a certain m/z -ratio (depending on the applied voltage) have a stable path and reach the detector, all other ions have unstable paths and collide with the electrodes. Hence, they do not reach the detector. When the voltage is increased, ions with a higher m/z -ratio pass the

mass analyzer and reach the detector. So a mass spectrum can be measured by changing the applied voltage. [18]

4.3.3 Ion Trap

Because of their similarity in principle to quadrupole mass analyzers, ion traps are known as quadrupole ion traps, or quadrupole ion storage, which means the trap can store ions. Considering its principle, an ion trap is similar to a quadrupole mass analyzer. It can be understood from Fig. 15.

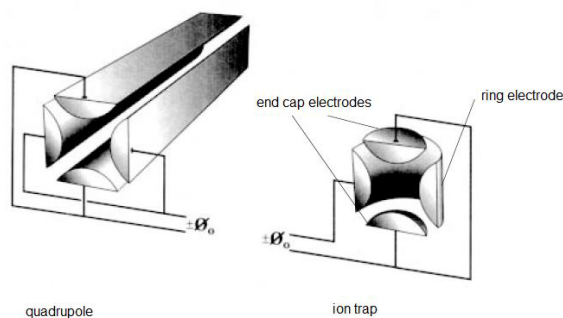

Fig. 15 quadrupole and ion trap

An ion trap consists of a ring electrode and a pair of fixed end cap electrodes. The sample is introduced and ions are ejected through the pores, which are drilled into the end cap electrodes. The ring electrode is isolated from the pair of equi-potential cap electrodes.

4.3.4 Time-of-flight (TOF) MS

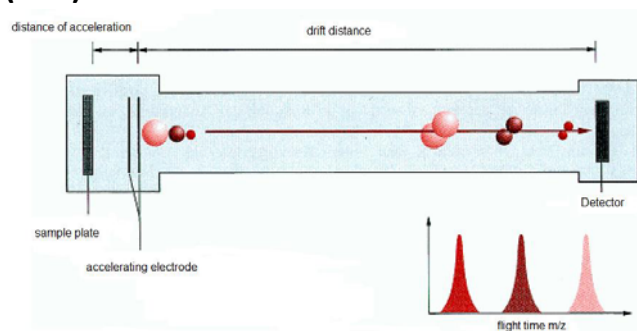

Fig. 16 TOF

The key part of the TOF is the ion drift tube. The principle of TOF is simple. Ions enter the drift tube and are accelerated by an acceleration voltage. As the ions possess the same amount of kinetic energy, the smaller the mass of the ions, the greater the velocity they maintain. Thus, light ions will arrive at the detector earlier than heavy ones.

Therefore, ion masses can be calculated from their flight times. In general, flight times are in microseconds, and they must be measured with an accuracy of nanoseconds.

The TOF has the following advantages:

1. It has no upper limit of measured mass, which is particularly suitable for biological research.
2. Because of its high scan speed, TOF can be used for the study of rapid processes. [18]

4.4 The mass spectrum

Ions with different mass-to-charge ratios are separated by a mass analyzer and recorded by a detector as a mass spectrum. The signal is combined to a line – so a line spectrum is obtained.

The ordinate shows the relative intensity of the ions and the abscissa the mass/charge rate. Mostly, the absolute intensity is only the value of the most intensive peak.

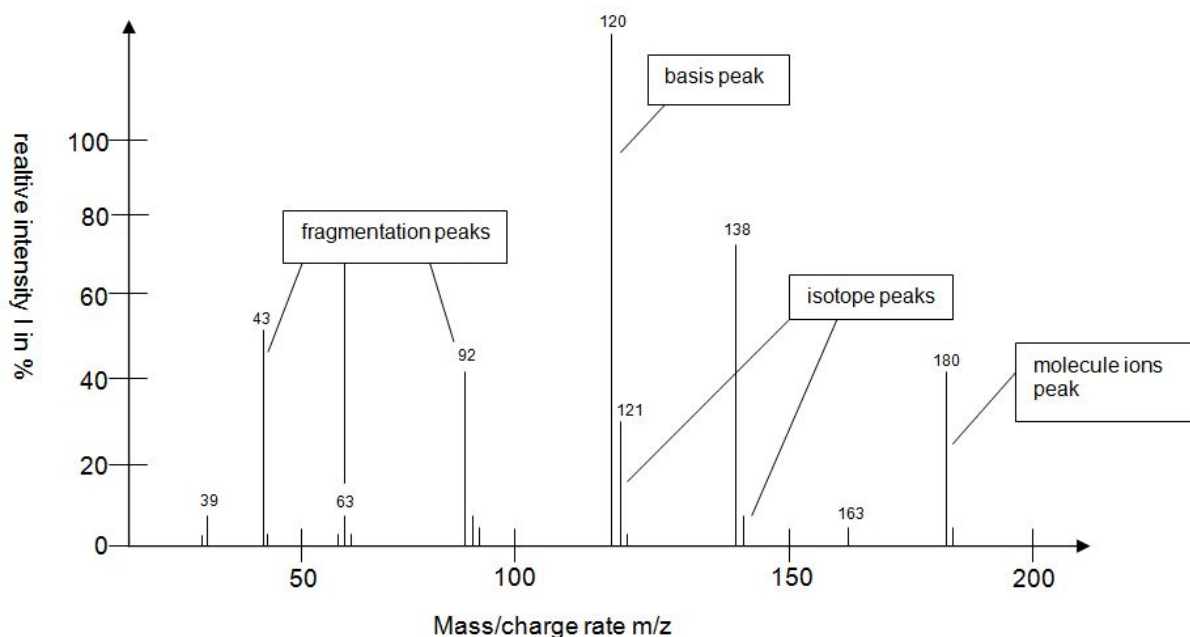

The signal with the highest mass is called the molecule peak and shows the molecular weight of the sample, at most times. If “hard ionization” was used, it can happen that all molecules break up and only fragments are measured.

Molecules consist of atoms which have a natural isotope distribution. So every peak in a mass spectrum has smaller neighbouring peaks, the **isotope peaks**. The intensity of the isotope peaks is used for calculation of the sort and the amount of atoms in the sample.

All signals in a mass spectrum where the mass is lower than the mass of the molecule ion are produced by fragmentation of the sample molecule. The peaks are called **fragmentation peaks** and give information about the structure of the analyt.

The **basis peak** is the signal with the highest intensity. For the calculation of the relative intensity, all peaks are compared to this peak. [16]

4.5 GC-MS

GC-MS means that MS is used as detector for GC.

The separation of mixtures can be performed by capillary gas chromatography in which the carrier gas flow is low. Therefore, the combination of capillary gas chromatography and mass spectrometry is easy to achieve. The two sets of instruments can be connected directly and the carrier gas is withdrawn with a vacuum pump (in most cases a turbo molecular pump is used). The components of the mixture are eluted sequentially from the capillary column, are then ionized and detected by MS.

The acquisition speed of the mass spectrometer must be rapid enough compared with the elution speed of the components so that the mass spectra can illustrate ion abundances correctly. Suppose that an acquisition starts at the beginning of an eluted peak and ends at the apex of the peak. The peaks in the lower m/z region of the mass spectrum will be suppressed because these ions have fairly low concentrations when they are ionized. If a mass spectrum is distorted, it cannot be used for mass spectrum retrieval.

Because the quadrupole mass analyzer has the advantages of rapid scan, reproducible mass spectra and low price, it is used most frequently in combination with GC.

A computer controls the operation. Acquisitions are carried out repeatedly. All data are stored on the hard disk. In addition to control, the computer has two further important functions:

1. The treatment of the acquired data.
 - a. The correction of the originally acquired data by background subtraction.
 - b. Showing a total ion current chromatogram, TIC, which is a chromatogram detected by the mass analyzer (not by an ordinary chromatographic detector).
 - c. Showing a mass chromatogram or the chromatogram of one kind of ions with a selected m/z value. For example, the components containing the benzene ring in a mixture can be seen when ions with an m/z value of 77 are selected.
This function can be extended to detect ions with two or more m/z values.
2. The retrieval of unknown mass spectra

5. Suzuki coupling

This important process is frequently used for cross – coupling and involves the palladium – catalyzed reaction of an organoboron compound (usually a boronic acid) with an alkenyl, alkynyl or aryl halide.

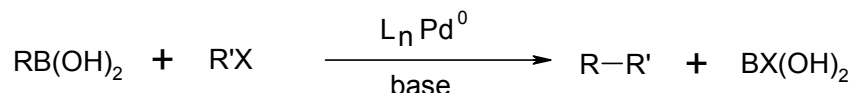

Boronic acids are easy to handle, air- and water-stable, thermo-resistant compounds. This relative inertness, however, requires quaternization of the boron atom to a boronate anion by means of bases such as OH^- , OAc^- , OEt^- , or F^- in order to generate good carbanion-transfer reagents. The classical catalytic cycle of the Suzuki reaction is hypothesized to proceed via neutral Pd^0 complexes:

5.1 Mechanism of the Suzuki Coupling

R' = alkyl, alkenyl, aryl

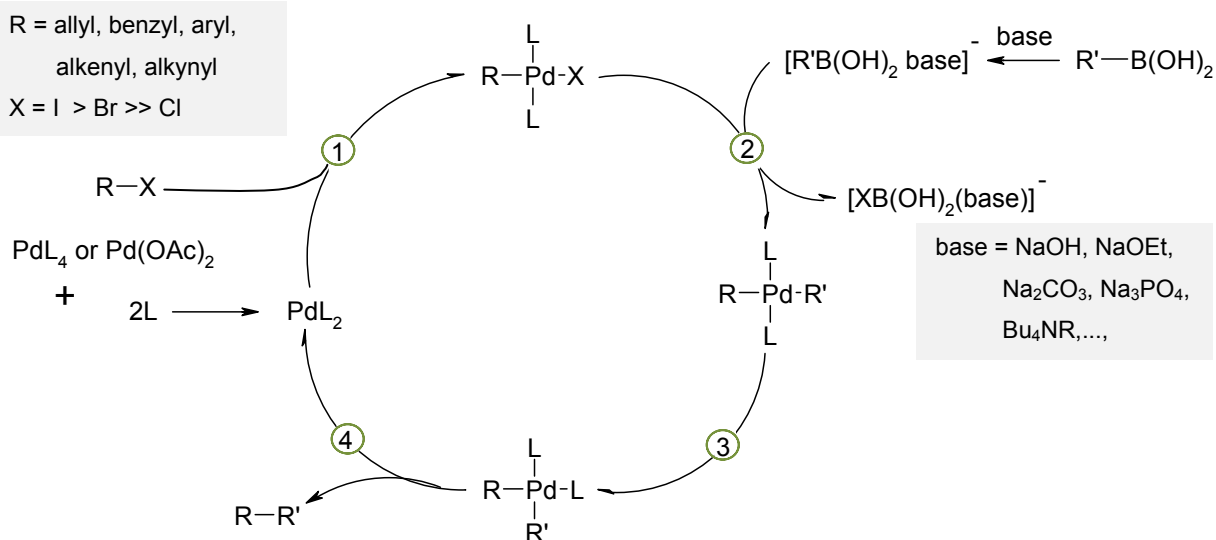

Fig. 17 Suzuki reaction [15]

The Suzuki reaction starts with an oxidative addition ①, then an X/R' exchange ② (transmetalation) takes place. After trans → cis rearrangement ③ a reductive elimination ④ completes the cycle. In the Suzuki reaction, anionic intermediates have recently been postulated in which the anion of the Pd^{II} precursor or X- from the reactant R – X remains coordinated to Pd^0 .

Besides the described problem-free handling of boronic acid derivatives, other factors that make the Suzuki reaction a method of choice are the tolerance of functional groups such as OH, NH, CO, NO₂ and CN, the low toxicity of the reagents, and the high selectivity of the cross-coupling. [15]

5.2 Transmetallation

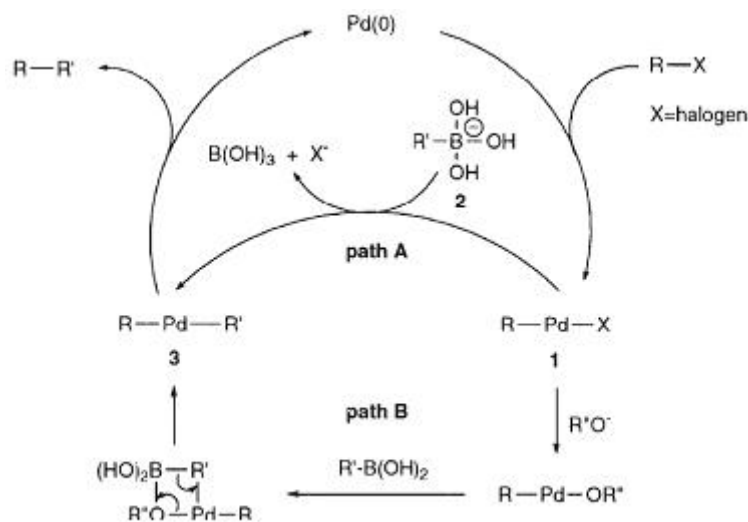

Fig. 18 Enlargement of the catalytic cycle of the Suzuki-coupling

For the transmetalation different reaction paths are possible, which are shown in Fig. 18. The chosen base depends on the reaction path (A or B) and also on the bororganyle. [20]

5.3 Advantage of the Suzuki coupling

An important characteristic of the coupling are the mild reaction conditions. The reaction takes place at room temperature and below, with weak alkaline reagents and the reaction tolerates many functional groups. The inorganic products produced during the reactions are easy to remove. The used reagents have a low toxicity. [20]

The advantages of the Suzuki reaction are demonstrated with three examples:

- Functional-group tolerance
- Regio- and stereocontrol in polyene synthesis
- Multiple coupling to poly-p-phenylene derivates [19]

Special part

R01: Synthesis of 4-Bromonitrobenzene (2)

As an important intermediate for the whole synthetic sequence, 4-Bromoaniline should be synthesised. A possible precursor is 4-Bromonitrobenzene.

Reaction mechanism

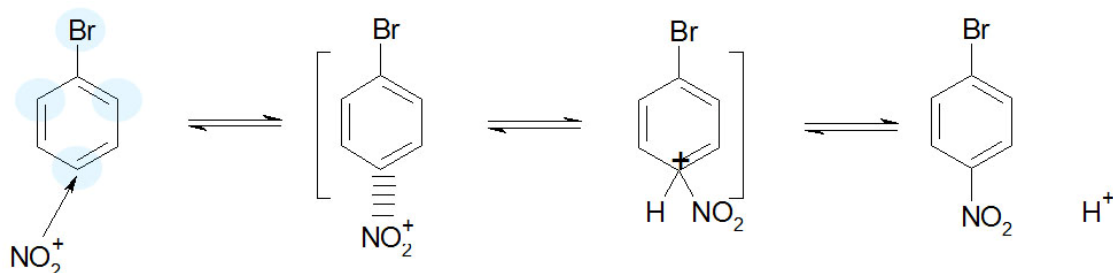
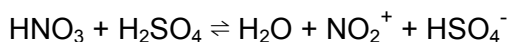

This reaction is an aromatic electrophilic substitution with a deactivating substituent (-I). Contrary to the -I-effect, bromine has a +M-effect, which directs the electrophil in ortho- and para-positions. There are two different explanations.

The rather simple explanation is that this substituent donates electrons into the ring system. These electrons are not equally divided over the whole ring, but concentrated in ortho and para position. The electrophile is, in this case, an NO_2^+ which is produced from HNO_3 and H_2SO_4 . Electrophiles are substances which are attracted to electrons. Therefore, the NO_2^+ is either directed to the para- or to the ortho-position of the ring system. Due to sterical hindrance,

p-Bromonitrobenzene is preferably formed.

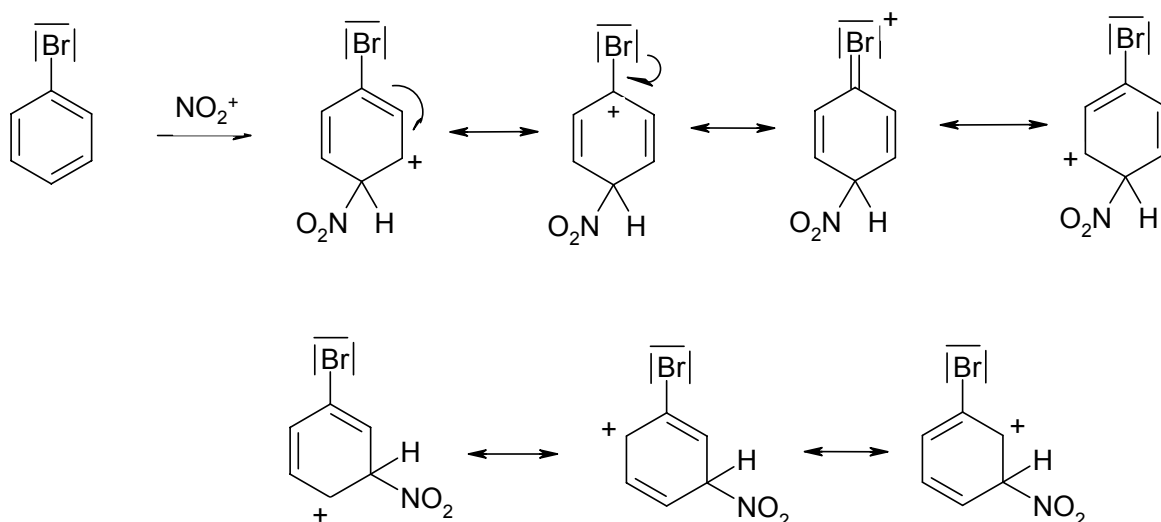

In reality, it directs in ortho- and para-position because they are more stable due to their mesomeric forms. As shown above, the para-position (as well as the not-shown ortho-

position) has four mesomeric forms while the meta-position has just three. The more mesomeric forms, can be constructed the more stable a molecule is.

Process

The reaction was performed according to an oral communication with Horkel. Nitrating acid was produced and solely added to a cooled solution of bromobenzene and acetic anhydride. The obtained product was sucked dry and washed with water. Because product crystallized in the filtrate, it was mixed with ice water, stirred until complete hydrolysis of Ac_2O , sucked dry again and washed with ice water.

As the yield was not satisfactory, the reaction was performed again. This time, the reaction mixture was directly poured into ice water, sucked dry and washed with ice water. Thereby, a better yield (36%) was obtained.

R02: Synthesis of 4-Bromoaniline (3)

Reaction mechanism

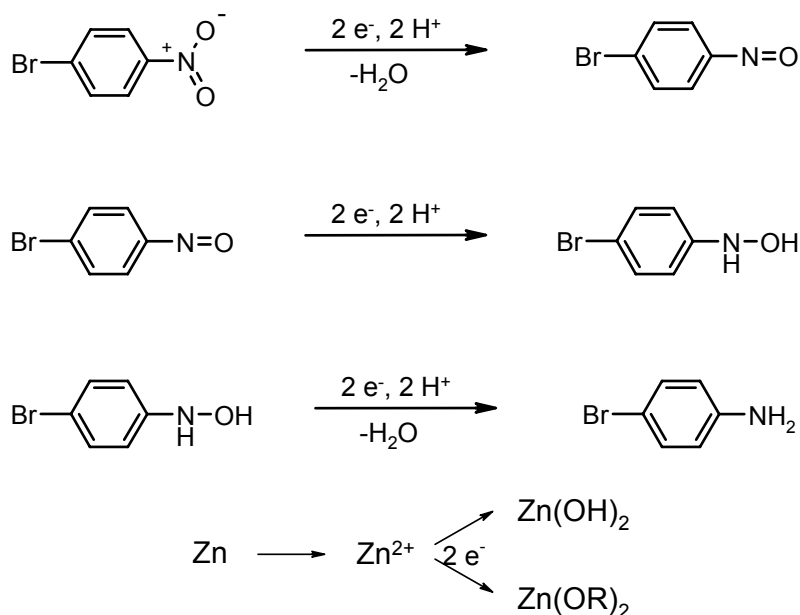

This reaction is a redox reaction. p-Bromonitrobenzene is reduced in three steps to p-bromoaniline. Each step emits two electrons. These are used to oxidize zinc and therefore, three equivalents of zinc are required. Depending on the used solvent Zn(OH)_2 (water as solvent) or Zn(OR)_2 (organic solvent) is formed.

Process

The reaction was performed according to [21] but using a smaller amount of zinc. First, 3 eq of zinc and 6 eq of zinc were used. A TLC showed that 3 eq of zinc (theoretical minimum) were practically not enough to achieve complete reduction. The reaction works properly when using 6 eq of zinc. Nevertheless, it was attempted to reduce this amount of zinc. Hence, the reaction was repeated with 3 eq, 3.3 eq and 4 eq zinc while using an ultrasonic bath activate the zinc surface. This time, product was achieved with the 3 eq-reaction but at a rather low yield (27.3%). The 4 eq- as well as the 3.3 eq-reaction worked properly (both about 70 %). It was also tried to use MeOH instead of water as solvent at room temperature. Product was obtained but the reprocessing was impossible because the obtained mixture had a slimy consistence due to the Zn(OR)_2 .

A hydrogenation with Pd as catalyst was also tried but no product was obtained (structures of reaction products were not completely elucidated, but suggested that a debromination took place). Additionally, a bromination with NBS was performed according to [22], but achieved no satisfactory result.

R03: Synthesis of 4-Iodotoluene (6)

Reaction mechanism

This reaction is a Sandmeyer-reaction.

Since nitrous acid is instable at room temperature, it is produced in situ by adding sodium nitrite to hydrochloric acid at $< 5^{\circ}\text{C}$.

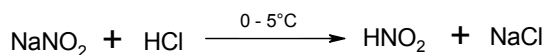

Protonation of nitrous acid forms the nitrosonium ion (NO^+).

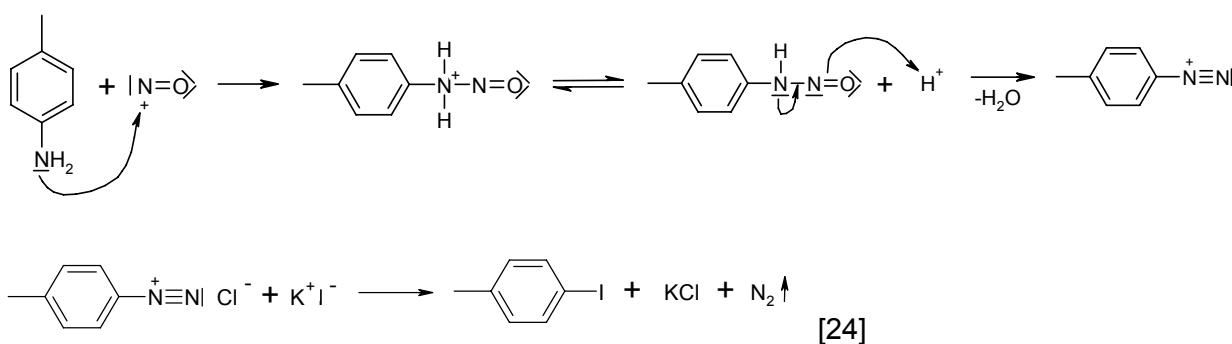
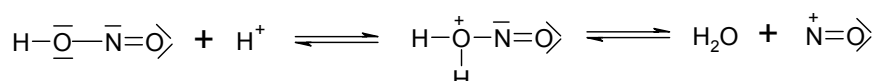

Process

At first, an iodation of toluene was tried according to [23] by refluxing potassium iodide, sulphuric acid and toluene for 1.5 h. During the reaction the condenser became dark (black at the bottom; gradually becoming brighter; yellow at the top). After work up, no product was achieved. The reaction was repeated, this time the sulphuric acid was slowly added through a dropping funnel. This time, the condenser was cleaner (still yellow but not black). Again, no product could be achieved. Nevertheless, the reaction was repeated. This time the substances were dissolved in n-hexane before adding the acid. Again, no product was achieved.

Consequently, a different reaction was used (see “reaction mechanism” above). The experiment was performed according to [25] with some optimizations. Before adding the KI-solution, urea was used for the decomposition of HNO_2 . At the end, the product was not purified by column chromatography but by vacuum distillation. Two fractions of product were obtained. First, the product had a dark red colour (1st fraction) and then it turned bright orange (2nd fraction). The first fraction was recrystallized from ethanol. In a second attempt the reaction was stirred with a mechanical stirrer. The urea was added more slowly and the product was purified by filtration through a pad of silica gel using PE as solvent. Compound **6** was obtained in 84% yield.

R04: Synthesis of 4-Bromo-N,N-bis(4-methylphenyl)-benzenamine (7)

Reaction mechanism

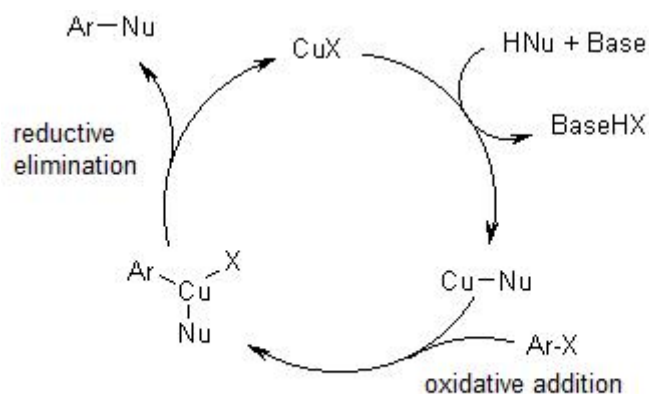
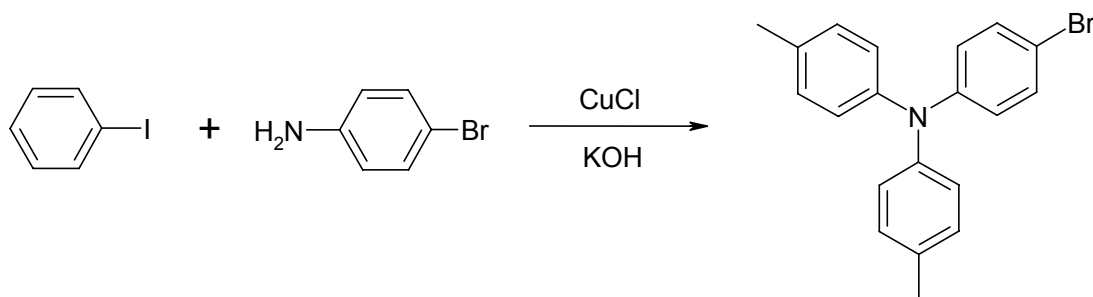

Fig. 19 Ullmann-condensation [27]

This reaction is an Ullmann reaction. In this case CuX is CuCl, Base is KOH, HNu is 4-bromonaniline, BaseHX means KCl + H₂O and Ar-X is 4-iodotoluene.



Process

The reaction was performed according to [26] by refluxing the reactants over night in a flask equipped with a dean stark trap. The only difference was that the obtained product was not decolorized with Filtrol-24 but instead the aqueous phase was additionally extracted with chloroform. The organic phase was decolorized with activated carbon and then dried over sodium sulphate. Afterwards it was filtrated through hyflo (solvent: chloroform). Each fraction was checked with TLC and all fractions which contained product were combined. The solvent was removed under reduced pressure and the obtained solid recrystallized from methanol.

Since the refining was not satisfactory, a series of experiments followed. At first, a small portion of the crude product was dissolved in toluene, extracted with acetic acid (20%), dried over Na₂SO₄ and filtrated. No improvement of product quality was achieved. Therefore, aluminium oxide was added to the filtrate, in order to adsorb the impurities, stirred over night. After filtration and evaporation of the solvent the obtained solid was still impure. So it was dissolved again in toluene and hexane was added to precipitate the product. The solid was sucked dry. The solid obtained by filtration was obviously not the desired product. For a

second try, again a small amount of crude product was dissolved in toluene and it was attempted to precipitate it with hexane, which failed. Thirdly, a sample of the crude substance was purified by Kugelrohr distillation. The obtained product was recrystallized from hexane and methanol. The recrystallization from methanol led to 64.9% of product which was pure according to NMR.

R05: Synthesis of Tris(1-methylethyl) boric acid ester (9)

Reaction mechanism

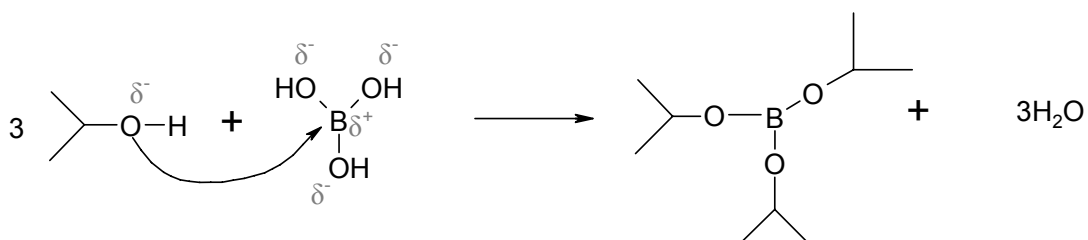

This reaction is a standard-type esterification (alcohol + acid \rightleftharpoons ester + water).

Process

Boric acid, isopropanole and benzene (toluene does not work) as an entrainer were heated on a dean-stark trap for 60 h. After evaporation of the solvents at normal pressure, the residue was fractionated in vacuum to give 75% of title compound.

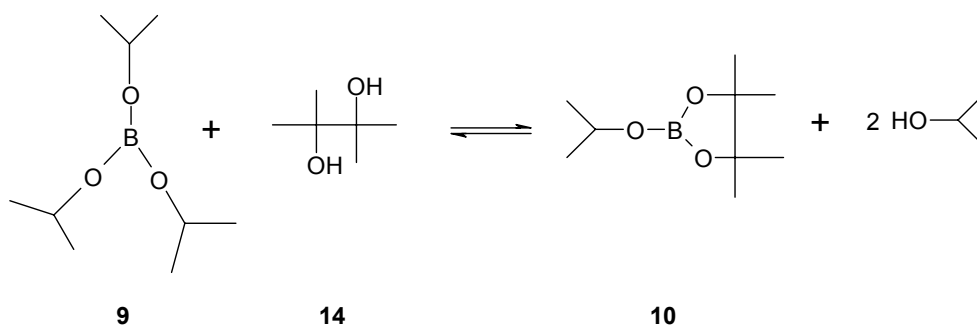
R06: Synthesis of 4,4,5,5-Tetramethyl-2-(1-methylethoxy)- 1,3,2-dioxaborolane (10)**Reaction mechanism**

This transesterification is an equilibrium reaction. Nonetheless, **10** is more stable than **9** due to the “chelate effect”. This effect explains why multidentate ligands create more stable structures than monodentate ligands. There are two explanations for this effect:

The thermodynamic chelate effect describes the entropy change during the reaction. On the left side, there are 2 mol, while there are 3 mol on the right side. More molecules cause more disorder and disorder is the natural state of the universe.

The kinetic chelate effect means that if one side of the multidentate ligand is bond, the other side is rather near. Therefore, it is more probable that it binds than that an iso-propanol, which could be anywhere in the solution, binds. [29]

Process

The reaction was performed according to [28] by distillation of the reactants. The reaction was repeated once. Firstly, with **14**, secondly with dry **14**. The second attempt provided a better yield, due to the fact that water reacts with esters and therefore partially hydrolysis the triisopropylborate (ester + water \rightleftharpoons acid + alcohol).

R07: Synthesis of

2-[4-[Bis(4-methylphenyl)amino]phenyl]-4,4,5,5-tetramethyl-1,3,2-dioxaborolane (11)

Reaction mechanism

The first reaction step is a metal-halogen exchange:

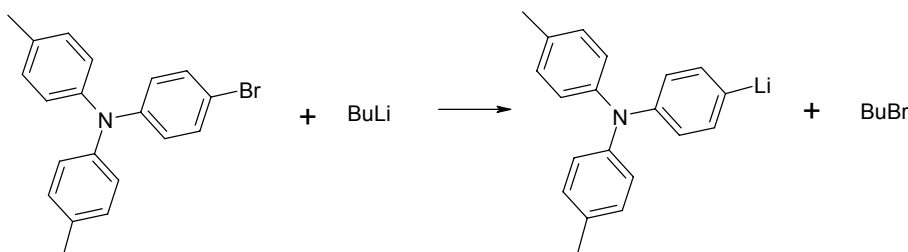

This leads to a negative partial charge at the carbon bond to the lithium, enabling a nucleophilic attack at the boron.

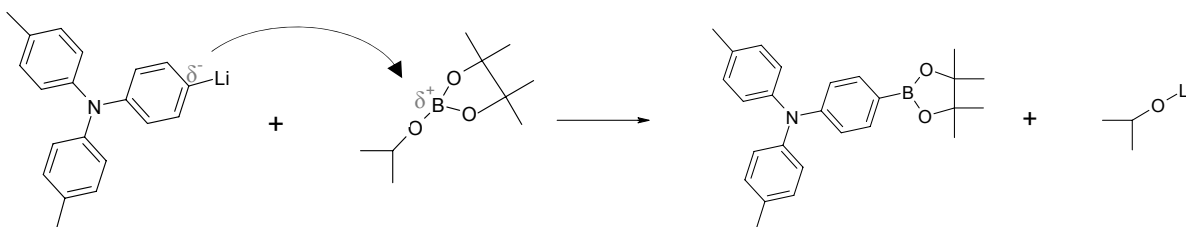

The isopropylate group is the most probable leaving group due to the Chelat-effect (as explained on p. 44).

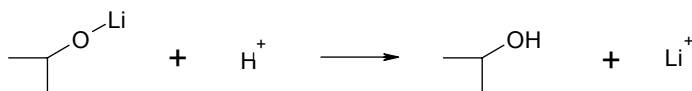

Process

The reaction was performed according to [30] by adding n-BuLi to a solution of Cap-Br at -90°C. After stirring for 2 h the ester was added and the reaction completed by stirring over night at room temperature. Since the organic phase of the extraction was black, it was stirred with activated carbon and filtrated through hyflo before recrystallization from methanol. The required results were obtained. Compound **11** was obtained in 59% yield.

R08: Synthesis of 4,4,5,5-Tetramethyl-2-(2-thienyl)-1,3,2-dioxaborolane (15)

Reaction mechanism

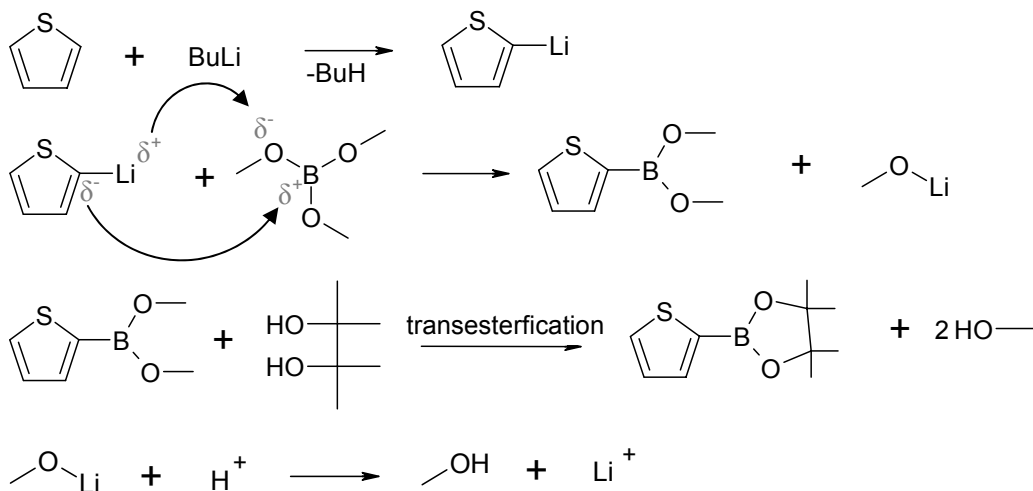

Process

The reaction was performed according to an oral communication with Horkel. The result was satisfactory (yield: 67%), so no further experiments were necessary.

R09: Synthesis of 5,5'-Dibromo-2,2'-bithiophene (17)**Reaction mechanism**

2,5-Dibromothiophene is lithiated with n-BuLi. Then CuBr₂ is used to form a radicalic intermediate, which combines to form the title compound.

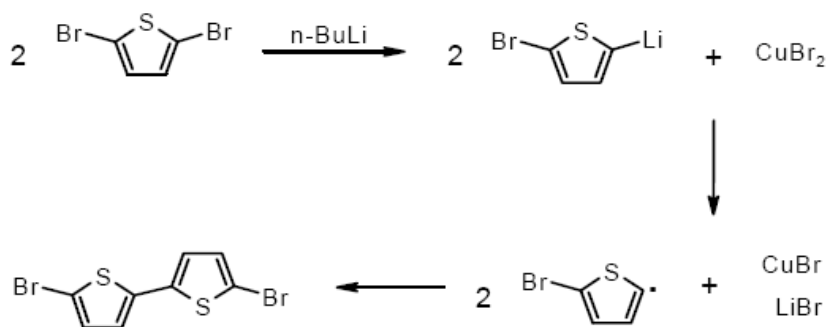
**Process**

The reaction was performed according to [31] (by adding n-BuLi to a cooled solution of dibromothiophene, stirring for 2 h, adding CuBr₂ and then stirring over night at room temperature) with the differences that n-BuLi and CuBr₂ were added at < -90°C (instead of -78°C), the reaction mixture was extracted with ether and 2 N HCl (instead of CHCl₃ and 15% HCl). At the end, the combined organic phase was additionally washed with saturated NaCl-solution to achieve a better phase separation. Additionally, different solvents for recrystallization were tried. The crude product was recrystallized from methanol and ethanol. Both recrystallizations achieved the same yield, but the solid did not completely dissolve in methanol. The reaction was repeated twice, each time with a different recrystallization methods. It was recrystallized from ethanol + activated carbon and once from cyclohexane + activated carbon. The last method achieved the purest product in 54% yield.

During the work up the aqueous phase contained a solid so it was sucked off and washed with ether. Additionally, it was tried to dissolve it in 2 N HCl which dissolved most of the solid. It was noticed that 2 N HCl caused a better phase boundary, maybe the reaction mixture should be poured on ice-cold 2 N HCl instead of ice-water.

R10: Synthesis of 19**19a** 2,2':5',2'':5'',2'''-Quaterthiophene**Reaction mechanism**

This reaction is a Suzuki coupling (see p. 29) where R-X is **17**, R'-B(OH)₂ is **15** and the base is KO^tBu.

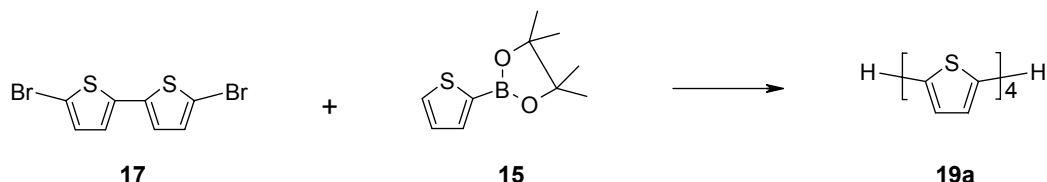
**Process**

The reaction was performed according to an oral communication with Horkel by heating the reactants over night. In order to maximize yield, a screening of the catalyst system was performed. Once with Pd(PPh₃)₄ + K₂CO₃ and once with (IPrⁱ)Pd(η³-allyl)Cl + KO^tBu. The latter produced no product. The first version was varied by using DME instead of THF and CsCO₃ instead of K₂CO₃ but no change of yield was achieved. Product **19** was obtained in 46% yield.

19b 2,2':5',2''-Terthiophene**Reaction mechanism**

This reaction is a Suzuki coupling (see p. 29) where R-X is **16**, R'-B(OH)₂ is **15** and the base is KO^tBu.

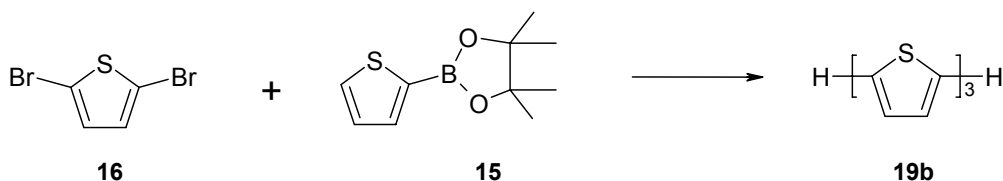
**Process**

The reaction was done according to the optimized synthetic path of **19a**.

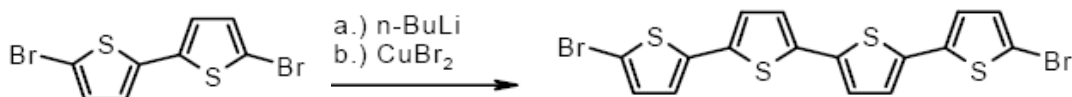
R11: Synthesis of 5,5''-Dibromo-2,2':5',2'':5'',2'''-quaterthiophene (18)**Reaction mechanism**

The reaction mechanism is similar to R09 (see p. 47).

Process

The reaction was first performed according to R09 (see p. 61) but no product was obtained. So it was repeated with dry THF as solvent (instead of dry ether). This time product was achieved and extracted three times with CHCl₃ and twice with ether. The combined organic layer was washed with 2 N HCl, saturated NaHCO₃-solution and saturated NaCl-solution. Then it was dried over Na₂SO₄ and filtrated through hyflo. After evaporation of the solvent a crude product was obtained. At this moment, no further protocol can be given to achieve separation for the title compound from the various side products.

R12: Synthesis of 20**20a** 4,4'-(2,5-Thiophenediyl)bis[N,N-bis(4-methylphenyl)-benzenamine]**Reaction mechanism**

This reaction is a Suzuki coupling (see p. 29) where R-X is **16**, R'-B(OH)₂ is **11** and the base is KO^tBu.

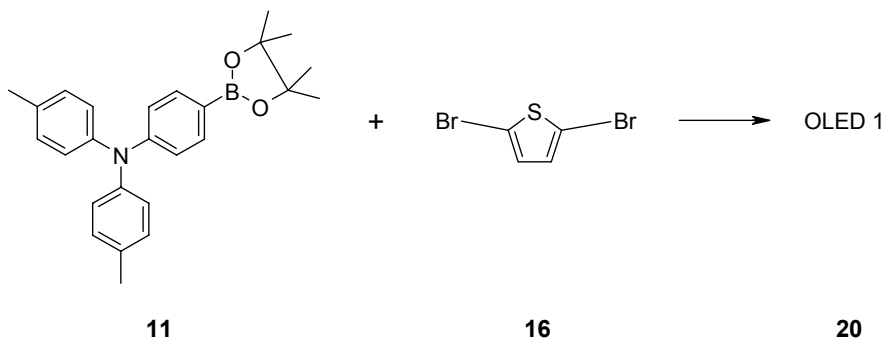
**Process**

The reaction was performed according to an oral communication with Horkel. After standard work up and purification by column chromatography, compound **20a** was obtained in 77% yield.

20b 4,4'-[2,2'-Bithiophene]-5,5'-diylbis[N,N-bis(4-methylphenyl)-benzenamine]**Reaction mechanism**

This reaction is a Suzuki coupling (see p. 29) where R-X is **17**, R'-B(OH)₂ is **11** and the base is KO^tBu.

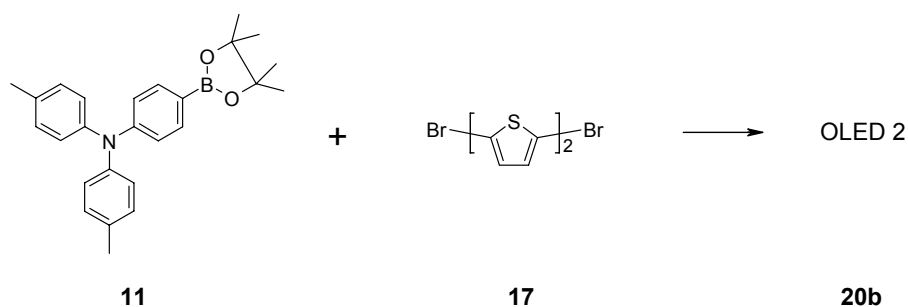
**Process**

The reaction was performed according to an oral communication with Horkel. After standard work up and purification by column chromatography, compound **20b** was obtained in 39% yield.

Experimental part

Analytical Equipment

Melting points

Melting points were determined on a Leica Galen III Kofler type hot stage microscope and are uncorrected.

GC/MS measurements

GC/MS measurements were performed on a GC/MS hyphenation system from Thermo Finnigan; gas chromatograph: GC 8000 Top with a BGB5 column ($l = 30\text{m}$, $d_i = 0.32\text{mm}$, $1\mu\text{m}$ film thickness); mass spectrometer: Voyager Quadrupol (electron impact ionization)

NMR spectroscopy

NMR spectra were recorded on a Bruker DPX – 200 or Advance DRX - 400 Fourier transform spectrometer. The shifts are referenced to tetramethylsilane and are denoted in ppm. For the calibration the solvent signal was adjusted to 7.26 (CDCl_2) or 5.32 (CD_2Cl_2). The multiplicities are named: s = singlet, d = duplet, t = triplet, q = quartet, m = multiplet

R01: Synthesis of 4-bromonitrobenzene (2)

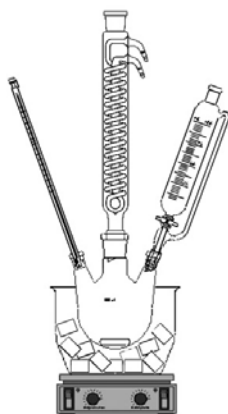
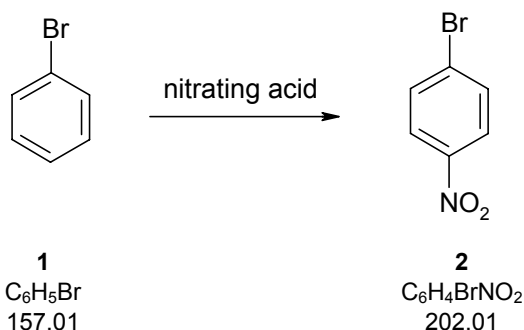

Fig. 20 R01

With a syringe bromobenzene **1** (1 eq, 3.95 g, 23 mmol) was added into a 100 mL three-necked flask equipped with a condenser, a thermometer and a dropping funnel (see Fig. 20), then 20 mL of acetic anhydride were added. With a freezing mixture the flask was cooled to <0°C.

Meanwhile, nitrating acid was produced by carefully adding concentrated sulphuric acid (H₂SO₄, 3 eq, 6.98 g, 69 mmol) to an ice-cooled flask containing fuming nitric acid (conc. HNO₃, ρ = 1.41 g/mL, 1.1 eq, 1.68 g, 25.3 mmol).

With a dropping funnel this nitrating acid was slowly added to the three-necked flask (T<5°C). The progress of reaction was monitored with GC-MS.

The reaction mixture was poured onto 100 mL of ice water and stirred for 10 min. Then the precipitate was sucked off, washed with ice water and dried in vacuum (15 mbar/40°C).

The obtained solid was recrystallized from n-hexane (12.9 mL/g crude) and filtrated while still being hot. After cooling to room temperature, the formed crystals were sucked, washed with n-hexane and dried in vacuum(15 mbar/40°C).

1.67 g (36%) of **2** were obtained as a white powder with a melting point of 120-123°C (literature: 125 – 127°C [32]).

R_f = 0.68 (PE : EE = 9 : 1)

¹H-NMR (200 MHz, CDCl₃): δ = 8.09 (d, J = 9.00 Hz, 2 H), 7.68 (d, J = 9.00 Hz, 2H) ppm

R02: Synthesis of 4-bromoaniline (3)

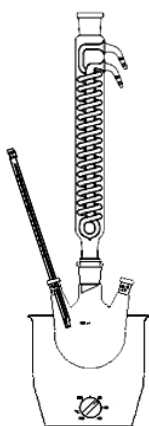
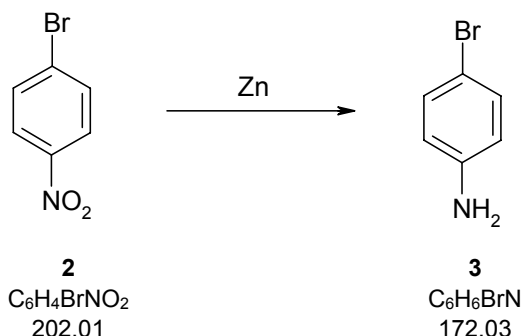

Fig. 21 R02

Compound **2** (1 eq, 2.02 g, 10 mmol) was weighed into a 50 mL three-necked flask. Zinc (3.3 eq, 2.16 g, 33 mmol) and ammonium chloride (NH_4Cl , 2 eq, 1.07 g, 20 mmol) were added with 50 mL of water to the three-necked flask. The flask was equipped with a thermometer and a condenser (see Fig. 21) and heated to 80°C in an ultrasonic bath for 3 h 30 min. The Progress of reaction was monitored with TLC.

The reaction mixture was transferred into a separatory funnel. Afterwards 30 mL of ether were poured through the condenser into the flask and it was tried to dissolve the solid part of the reaction mixture in the flask. This ether was used for extraction of the reaction mixture in the separatory funnel. This procedure was repeated twice. The last time 10 mL of saturated NaCl-solution

were added to gain a better phase separation. The combined organic phase was dried over sodium sulphate, filtrated and the solvent was removed under reduced pressure.

1.212 g (70 %) of **3** were obtained as white powder with a melting point of $57 - 60^\circ\text{C}$ (literature: 66°C [32]).

$R_f = 0.35$ (PE : $\text{CH}_2\text{Cl}_2 = 1 : 2$)

Since GC-MS showed that the product was clean enough for our purposes, it was not further purified and therefore no NMR was measured.

R03: Synthesis of p-iodotoluene (6)

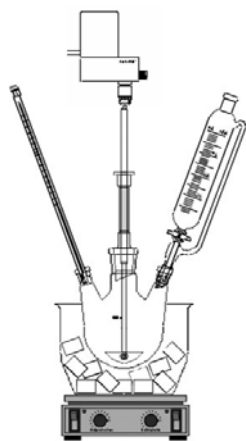
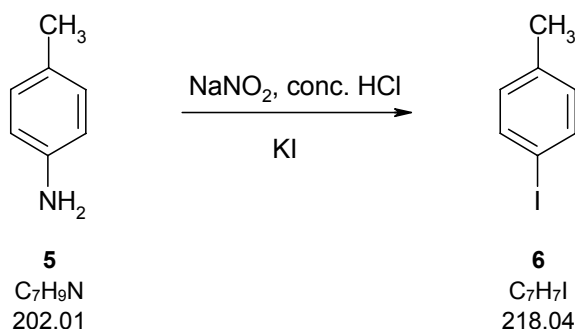

Fig. 22 R03

Sodium nitrite (NaNO_2 , 1.05 eq, 36.54 g, 0.53 mol) was dissolved in 150 mL of water and transferred into a dropping funnel. 300 mL of water and 125 mL of concentrated HCl were given into a 500 mL three necked flask equipped with a thermometer and the dropping funnel (see Fig. 22), then p-toluidine **5** (1 eq, 53.64 g, 0.5 mol) was added. The flask was cooled to $<5^\circ\text{C}$ with an ice bath before slowly adding the sodium nitrite solution. The mixture was stirred for 1 h 15 min, then urea was added slowly until NaNO_2 was eliminated (checked with potassium-starch-paper after stirring for a while).

Potassium iodide (KI, 1.1 eq, 92.54 g, 0.55 mol) was dissolved in 60 mL of water and added dropwise. This solution was stirred over night.

A black solid in a red solution was obtained, the solution was poured into a 1 l separatory funnel and the solid was dissolved in 250 mL of ether, then it was added to the separatory funnel. This mixture was shaken and the phases separated. The aqueous phase was extracted with 250 mL of ether three times, the organic phase was shaken out with 250 mL of saturated sodium bisulfite solution, dried over sodium sulphate, filtrated and the solvent was removed under reduced pressure.

The residue was dissolved in petroleum ether and filtrated through silica gel (solvent: petroleum ether, 200 mL/fraction). TLC was used to check which fraction contained product, these fractions were mixed and the solvent removed under reduced pressure.

The obtained red-orange crystals were dissolved in DCM, decolourized with activated carbon, filtrated through hyflo and the solvent removed under reduced pressure.

91.08 g (84%) of **6** were obtained as white crystals with a melting point of $33 - 34^\circ\text{C}$ (literature: $34.5 - 35^\circ\text{C}$ [33]).

$R_f = 0.67$ (PE)

$^1\text{H-NMR}$ (200 MHz, CDCl_3): $\delta = 7.57$ (d, $J = 8.21$ Hz, 2 H), 6.94 (d, $J = 8.41$ Hz, 2 H), 2.31 (s, 3 H) ppm

R04: Synthesis of 4-Bromo-N,N-bis(4-methylphenyl)-benzenamine (7)Also known as: **Cap – Br**

Fig. 23 R04

In a 500 mL three-necked flask equipped with a dean stark trap potassium hydroxide (KOH , 7.8 eq, 43.76 g, 780 mmol), 200 mL of toluene, **6** (2.2 eq, 48.24 g, 220 mmol), **3** (1 eq, 17.22 g, 100 mmol) and phenanthroline (0.04 eq, 0.79 g, 4 mmol) were added.

The apparatus was flushed with nitrogen, then copper chloride (CuCl , 0.04 eq, 0.92 g, 4 mmol) was added. The reaction was refluxed under nitrogen atmosphere over night. The progress of reaction was monitored with GC-MS.

The reaction was cooled to room temperature. The mixture was extracted with 150 mL of water in a 500 mL separatory funnel. The aqueous phase was extracted with 100 mL of toluene and the combined organic phase was washed with 100 mL of saturated NaCl -solution (The phase boundary was nearly invisible since both phases were black. Only at the end of the separatory funnel it was possible to see that the organic phase was dark red and the aqueous phase was brown), dried over sodium sulphate, filtrated and the solvent removed under reduced pressure.

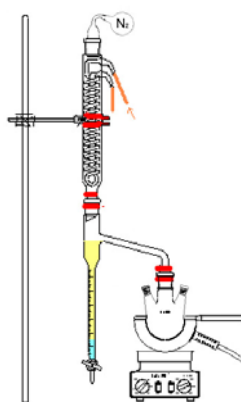
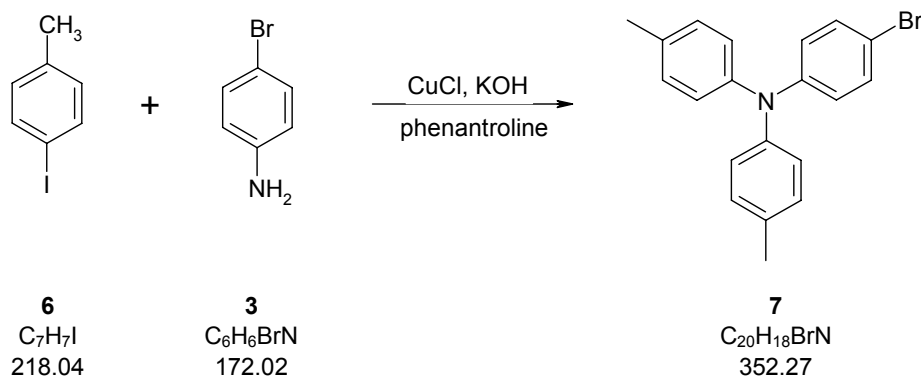
The residue was Kugelrohr distilled ($2.5 - 3.0 \cdot 10^{-1}$ mbar, 200°C) and the obtained solid purified by recrystallization from methanol (3.6 mL/g crude).

22.85 g (64.9%) of **7** were obtained as white solid with a melting point of $98-99^\circ\text{C}$ (literature: $103.5 - 104.5^\circ\text{C}$ [32]).

$^1\text{H-NMR}$ (200 MHz, CDCl_3): $\delta = 2.30$ (s, 6 H), 7.31 - 7.21 (m, 2 H), 7.11 - 6.82 (m, 10 H) ppm.

R05: Synthesis of Tris(1-methylethyl) boric acid ester (**9**)

Fig. 24 R05

In a four-necked flask equipped with a mechanical stirrer, a jacketed coil condenser, a heating mantle and a dean stark trap (see Fig. 24) were added: **8** (1 eq, 150.75 g, 2.44 mol), 1.5 l of isopropanole (8 eq, 1.5 l, 19.47 mol) and 1.5 l of benzene (toluene is no appropriate replacement). The reaction was refluxed for six days, 115.8 mL of water were separated. The solvent was removed under normal pressure to approximately 1 L and the residue purified by fractional distillation (K_p : 96-97°C at 200 mbar).

346 g (75%) of **9** were obtained as colourless liquid.

$^1\text{H-NMR}$ (200 MHz, CDCl_3): $\delta = 1.13$ (d, $J = 6.26$ Hz, 18 H), 4.33 (sept, $J = 6.11$ Hz, 3 H) ppm.

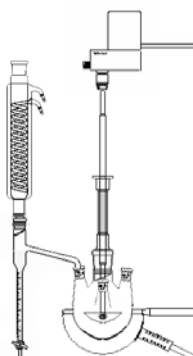
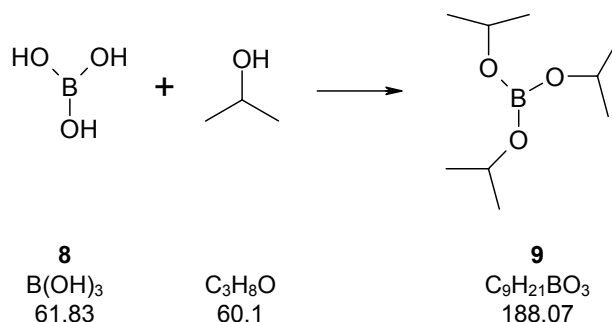
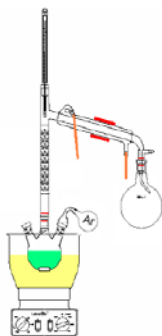
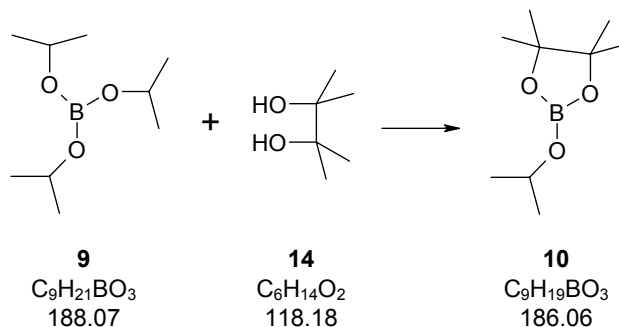
R06: Synthesis of 4,4,5,5-Tetramethyl-2-(1-methylethoxy)- 1,3,2-dioxaborolane (10)Also known as: **Pin – Bop**

In a three-necked flask dry pinacol (1 eq, 6.03 g, 50 mmol), n-hexane (10.7 eq, 70 mL, 536.1 mmol) and **9** (1 eq, 9.88 g, 50 mmol) were added. The latter was added with a syringe under argon atmosphere. Afterwards it was distilled under normal pressure until the azeotrope was removed (oil bath: 94°C). Then the bottom was vacuum distilled (25 mbar, oil bath: 110°C).

A 7.37-g product (79%) was obtained as colourless liquid with a boiling point of 78°C at 25 mbar.

1H -NMR (200 MHz, $CDCl_3$): δ = 4.32 (sept, J = 6.16 Hz, 1 H), 1.19 (d, J = 7.04 Hz, 6 H), 1.24 (s, 12 H) ppm

Fig. 25 R06

R07: Synthesis of

2-[4-[Bis(4-methylphenyl)amino]phenyl]-4,4,5,5-tetramethyl-1,3,2-dioxaborolane (**11**)Also known as: **Cap – Boron**

Fig. 26 R07

In a 500 mL four-necked flask equipped with a septum, a mechanical stirrer and a low-temperature thermometer (see Fig. 26) **7** (1 eq, 17.79 g, 50 mmol) and 250 mL of dry THF were added under argon atmosphere. The flask was cooled with liquid nitrogen to $< -90^{\circ}\text{C}$, then *n*-BuLi (2.5 M in hexane, 1.2 eq, 24 mL, 60 mmol) was slowly added with a syringe through the septum. The reaction mixture was stirred while being cooled for 2 h, then **10** (1.2 eq, 11.13 g, 60 mmol) was added with a syringe. The mixture was stirred at room temperature over night. The progress of reaction was monitored with GC-MS.

The solvent of the reaction mixture was removed under reduced pressure, the obtained solid was dissolved in 300 mL of chloroform and under vigorous stirring 100 mL of half concentrated HCl were added. The mixture was transferred into a separatory funnel and the phases were separated. The aqueous phase was extracted twice with 50 mL of chloroform, the combined organic phases were dried over sodium sulphate, filtrated and the filtrate was stirred, with activated carbon for 2h. The carbon was removed by filtration over hyflo, the hyflo pad was washed with chloroform. The solvent was removed under reduced pressure.

The solid was recrystallized from methanol, filtrated while still being hot, cooled and sucked dry.

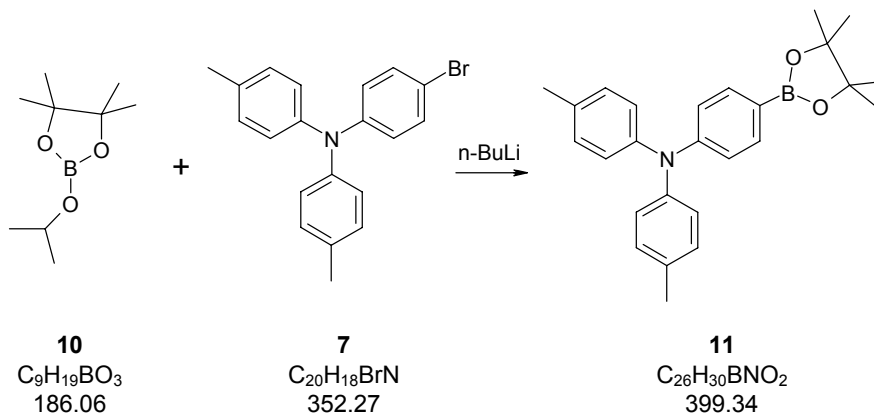
11.78 g (59 %) of **11** were obtained as white solid with a melting point of $144 - 147^{\circ}\text{C}$.

$^1\text{H-NMR}$ (200 MHz, CDCl_3): $\delta = 7.66$ (d, $J = 8.61$ Hz, 2 H), 2.34 (s, 6 H), 1.35 (s, 12 H), 7.17 - 6.93 (m, 10 H) ppm

R08: Synthesis of 4,4,5,5-Tetramethyl-2-(2-thienyl)-1,3,2-dioxaborolane (**15**)

Fig. 27 R08

In a three-necked flask equipped with a mechanical stirrer, a low-temperature thermometer, argon atmosphere and a septum **12** (1 eq, 6.39 g, 75 mmol) and 100 mL of dry ether were added under argon atmosphere. The flask was cooled to -40°C with liquid nitrogen and $n\text{-BuLi}$ (1.1 eq, 33 mL, 83 mmol, 2.5 M solution) was added with a syringe through the septum. The mixture was stirred at room temperature for 4 h, then it was cooled to -90°C and **13** (1.3 eq, 10.62 g, 0.1 mol) was added slowly through the septum ($T < -90^\circ\text{C}$). Cooling was stopped and after the reaction mixture reached room temperature **14** (1.3 eq, 11.82 g, 0.1 mol) was added with a syringe. The reaction was stirred at room temperature over night.

4.71 mL of concentrated acetic acid were added to 52.2 mL of absolute ether, then filled into a dropping funnel and added slowly to the reaction mixture. Immediately afterwards the mixture was filtrated over hyflo and washed with 300 mL of ether. The solvent of the filtrate was removed under reduced pressure.

The solid was recrystallized from methanol, the product filtered off and washed with ice-cold methanol. Then it was dissolved in a solution of PE : EE = 9 : 1 and filtered through a pad of silica gel with a solution of PE : EE = 9 : 1 (fractions: 80 – 90 mL). TLC was used to check which fraction contained the product, these fractions were combined, the solvent removed under reduced pressure and the obtained solid was recrystallized from n -hexane (4.2 mL/g crude).

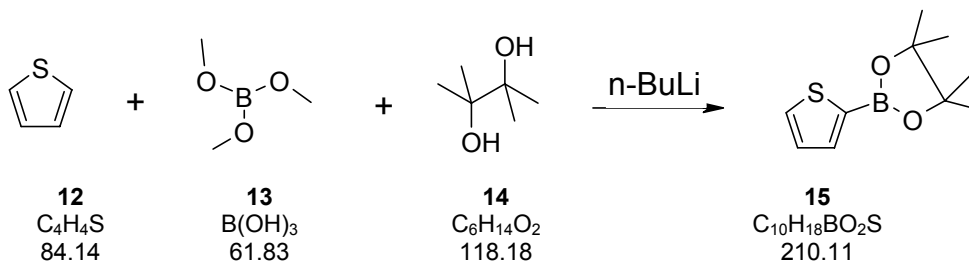
11,23 g (67%) of **15** were obtained as white solid with a melting point of $54 - 57^\circ\text{C}$.

$^1\text{H-NMR}$ (200 MHz, CDCl_3): $\delta = 1.35$ (s, 12 H), 7.20 (dd, $J = 4.60$ Hz, 3.42 Hz), 7.67 (dd, $J = 3.72$ Hz, 0.78 Hz), 7.64 (dd, $J = 4.98$, 0.68) ppm

R09: Synthesis of 5,5'-Dibromo-2,2'-bithiophene (**17**)

Fig. 28 R09 The reaction was stirred over night at room temperature.

In a 500 mL three-necked flask equipped with a mechanical stirrer, a low-temperature thermometer and a septum **16** (1 eq, 12 g, 49.4 mmol) and 200 mL of dry ether were added under argon atmosphere. The mixture was cooled to $< -90^\circ\text{C}$ with liquid nitrogen and *n*-BuLi (1.1 eq, 20.1 mL, 50.3 mmol, 2.5 M solution) was added with a syringe through the septum. The mixture was stirred at room temperature for 1.5 h, then it was cooled to -90°C and anhydrous copper bromide (CuBr_2 , 1.1 eq, 16.4 g, 50.3 mmol) was added.

The mixture was poured onto 300 mL of ice water and the phases were separated in a separatory funnel. Then the aqueous phase was extracted three times with 100 mL of ether. The precipitate in the organic phase was filtered off and washed with ether. The residue in the three-necked flask was dissolved in 100 mL of 2 N HCl and filtered too. The phases of the filtrate were separated in the separatory funnel. The combined organic phases were extracted with 100 mL of 2 N HCl, 200 mL of saturated sodium hydrogen carbonate solution and then with 100 mL of saturated sodium chloride solution. Afterwards it was dried over sodium sulphate, filtrated and the solvent was removed under reduced pressure.

The obtained solid was recrystallized from ethanol (18.3 mL/g crude), then it was cooled down for 2 min. and heated again with 2 spoons of activated carbon for 0.5 h. The mixture was filtrated hot, allow to cool and the formed crystals were filtered off.

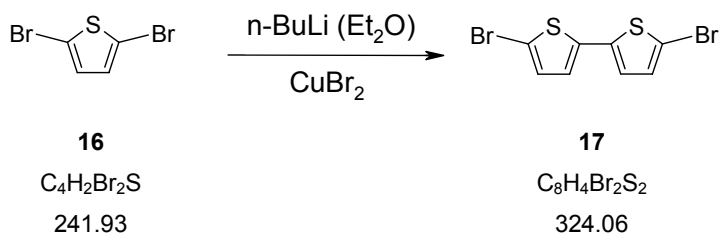
4.31 g (54 %) of **17** were obtained as silver solid with a melting point of $135\text{-}138^\circ\text{C}$ (literature: $146\text{-}147,6^\circ\text{C}$ [36]).

$^1\text{H-NMR}$ (200 MHz, CDCl_3): $\delta = 6.91$ (d, $J = 3.72$ Hz, 2 H), 6.84 (d, $J = 3.91$ Hz, 2 H) ppm

R10: Synthesis of 19

19a 2,2':5',2'':5'',2'''-Quaterthiophene

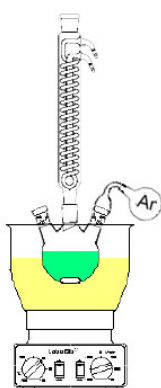
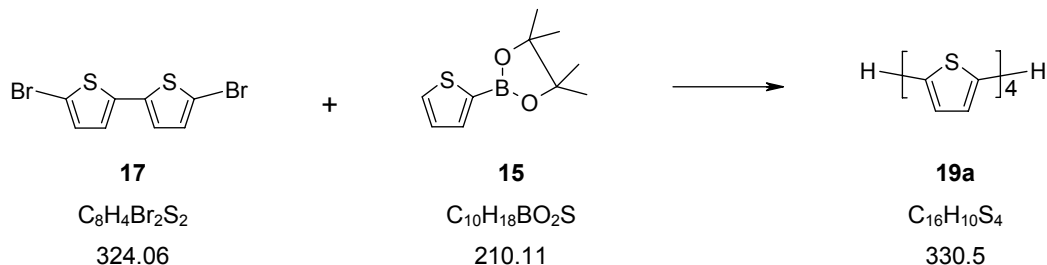

Fig. 29 R10

In a 50 mL three-necked flask equipped with a condenser the following substances were added **17** (1 eq, 975.2 mg, 3 mmol), **15** (2.4 eq, 1.5195 g, 7.2 mmol), Pd(PPh₃)₄ (5 mol-%, 352 mg, 0.15 mmol), 25 mL of dry THF and potassium carbonate solution (2 M K₂CO₃, 5.1 eq, 7.6 mL, 15.2 mmol). The mixture was heated under argon atmosphere over night. The progress of reaction was monitored with TLC.

The reaction mixture was transferred into a separatory funnel, 50 mL of water were used to wash the remaining substance from the flask into the funnel. Then it was extracted four times with 50 mL of chloroform. The combined organic phase was washed with 100 mL of saturated sodium chloride

solution, dried over sodium sulphate, filtrated and the solvent removed under reduced pressure.

This solid was purified by MPLC (solvent: cyclohexane, column: silica gel), because the solid was not soluble in cyclohexane, so dichloromethane and silica gel were added to the solid. Then the solvent was removed under reduced pressure. The obtained powder was given into a small column which was placed before the separation column. The flow was set to 3 mL/min, when it passed the sample column, the flow was increased to 28 mL/min. TLC was used to check which fractions contained product. These fractions were combined and the solvent removed under reduced pressure.

0.46 g (46%) of **19a** were obtained as neon-yellow solid (colour between yellow and green). ¹H-NMR (200 MHz, CD₂Cl₂): δ = 7.27 (dd, J = 5.09 Hz, 1.17 Hz, 2H), 7.21 (dd, J = 3.52 Hz, 1.17 Hz, 2H), 7.12 (s, 4H), 7.05 (dd, J = 5.09 Hz, 3.72 Hz, 2H) ppm

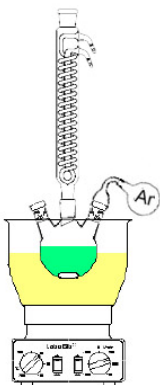
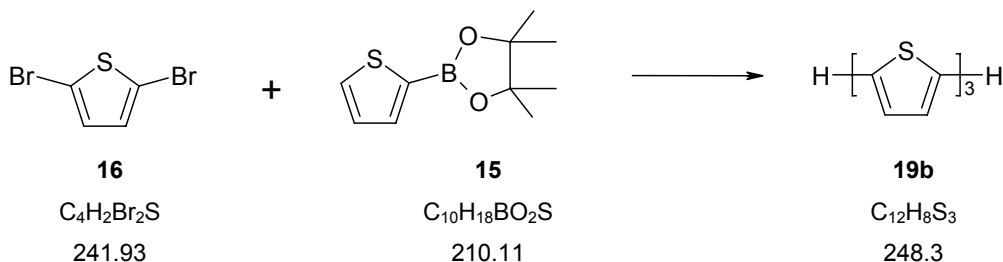
19b 2,2':5',2''-Terthiophene**Fig. 30** R10

In a 50 mL three-necked flask equipped with a condenser were added **16** (1 eq, 968.0 mg, 4 mmol), **15** (2.6 eq, 2.185 g, 10.4 mmol), Pd(PPh₃)₄ (5 mol-%, 231 mg, 0.2 mmol) and 18 mL of dry DME under argon atmosphere. Under slow stirring, a Caesium carbonate solution (1 M CsCO₃, 3 eq, 12 mL, 12 mmol) was added slowly with a syringe. The mixture was heated for 10 h, because GC-MS showed that the reaction was not finished, Pd(PPh₃)₄ (115.5 mg) and **15** (1.0925 g) were added and the mixture heated for 24 h.

Afterwards it was hydrolysed with water and extracted with CHCl₃ three times in a separatory funnel. The combined organic phase was dried over sodium sulphate, filtrated, 3.50 g silica gel added and the solvent removed under reduced pressure.

This solid was purified by MPLC (solvent: cyclohexane, column: silica gel), because the solid was not soluble in cyclohexane, dichloromethane and silica gel were added to the solid, then the solvent was removed under reduced pressure. The obtained powder was given into a small column which was placed before the separation column. The flow was set to 3 mL/min, when it passed the sample column the flow was increased to 28 mL/min. TLC was used to check which fractions contained product. These fractions were combined and the solvent removed under reduced pressure.

0.526 g (53%) of **19b** were obtained as neon-orange solid (colour between orange and yellow).

¹H-NMR (200 MHz, CDCl₃): δ = 7.23 (dd, J = 4.99 Hz, 1.08 Hz, 2H), 7.19 (dd, J = 3.52 Hz, 1.17 Hz, 2H), 7.09 (s, 2H), 7.03 (dd, J = 5.09 Hz, 3.72 Hz, 2H) ppm

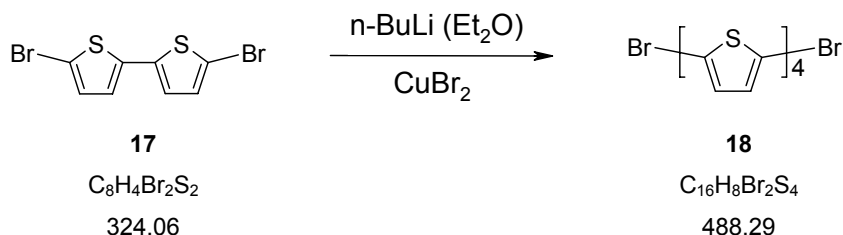
R11: Synthesis of 5,5''-Dibromo-2,2':5',2'':5'',2'''-quaterthiophene (18)**Fig. 31** R11

In a three-necked flask equipped with a mechanical stirrer, a low temperature thermometer, a septum and argon atmosphere were added 5,5'-dibromo-2,2'-**17** (1 eq, 1.63 g, 5 mmol) and 50 mL of dry THF. The flask was cooled to $< -90^\circ\text{C}$ with liquid nitrogen. Then anhydrous copper bromide (1.1 eq, 1.26 g, 5.5 mmol) was added and stirred by room temperature over night. The progress of reaction was monitored with TLC.

The reaction mixture was poured on 80 mL of ice water and extracted three times with chloroform in a separatory funnel. The aqueous phase was extracted with ether three times. The chloroform phase was washed with 80 mL of 2 N HCl, 80 mL of saturated NaHCO_3 -solution and 80 mL of saturated NaCl-solution. The combined organic phase was dried over sodium sulphate, filtrated through hyflo, washed with chloroform (800 mL). The solvent was removed under reduced pressure to give an unpurified product **18**.

Since the product was not purified, no NMR was measured.

R12: Synthesis of 20

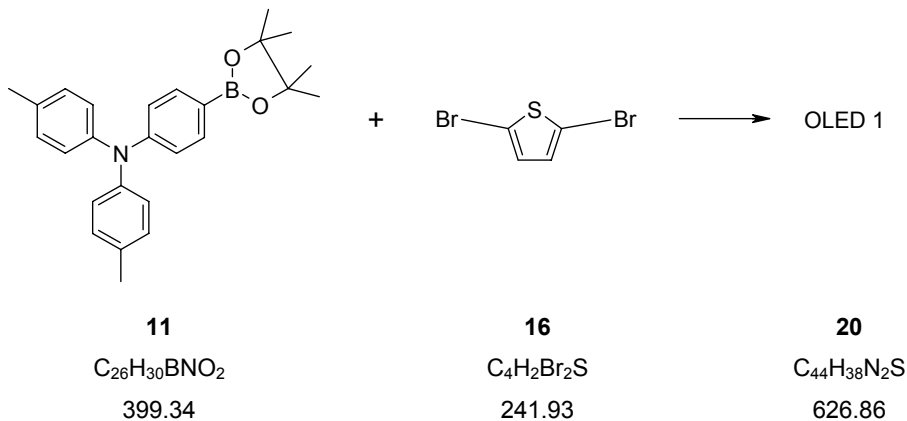
20a 4,4'-(2,5-Thiophenediyl)bis[N,N-bis(4-methylphenyl)-benzenamine]

A reaction vessel with **11** (2.5 eq, 100.4 mg, 0.25 mmol) was dried in a vacuum drying oven before it was sealed with a septum and set under argon atmosphere. Dried $(Pr^i)_2Pd(\eta^3\text{-allyl})Cl$ (2 mol-%, 2.4 mg, 0.004 mmol) was dissolved in 2 mL of degassed 2-propanol and added with a syringe to the reaction vessel. The mixture was stirred for 15 minutes and then **16** (1 eq, 24.5 mg, 0.1 mmol) and $KOtBu$ (2.75 eq, 32.4 mg, 0.275 mmol) were added. Afterwards the reaction vessel was degassed with argon, heated to 80°C and stirred over night. The progress of reaction was monitored with TLC.

The reaction was quenched by adding 3 mL of water to the test tube, the liquid was transferred to a 50 mL separatory funnel with a syringe. The reaction vessel was washed twice with 4 mL of dichloromethane, which was also used to extract the mixture in the separatory funnel. The aqueous phase was extracted three times with 10 mL of dichloromethane. The combined organic phase was washed with 20 mL of 2 N HCl, dried over sodium sulphate, filtrated and the solvent removed under reduced pressure. Afterwards the mixture was separated with MPLC (stationary phase: 40 g silica gel, solvent: cyclohexane with 6% DCM, gradient to 15% DCM). TLC was used to check which fractions contained product, these fractions were combined and the solvent removed under reduced pressure.

48 mg (77%) of **20a** were obtained as neon yellow solid, which was stored under argon atmosphere in a freezer.

1H -NMR (400 MHz, CD_2Cl_2): δ = 7.45 (d, J = 8.4 Hz, 4H), 7.16 (s, 2H), 7.11 – 7.09 (m, 8H), 7.01 – 6.98 (m, 12H), 2.33 (s, 12H) ppm

^{13}C -NMR (100 MHz, CD_2Cl_2): δ = 148.2 (s), 145.6 (s), 143.0 (s), 133.5 (s), 130.5 (d), 128.0 (s), 126.6 (d), 125.3 (d), 124.3 (d), 122.9 (d), 21.1 (q) ppm

1H -NMR is shown on page 69 and ^{13}C is shown on page 70.

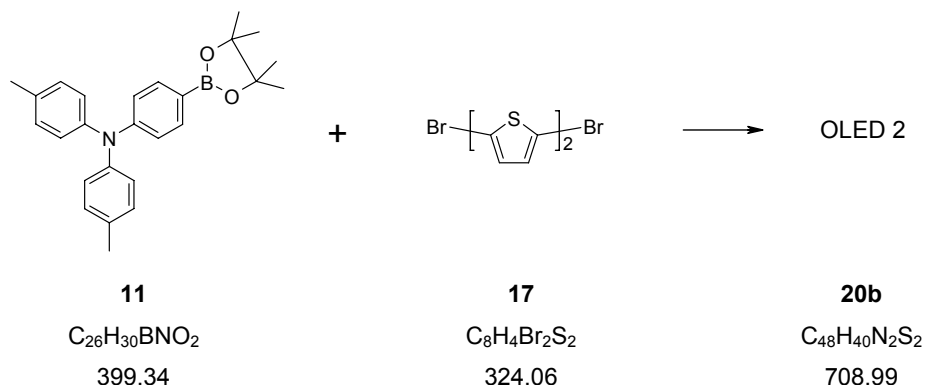
20b 4,4'-[2,2'-Bithiophene]-5,5'-diylbis[N,N-bis(4-methylphenyl)-benzenamine]

A reaction vessel with **11** (2.5 eq, 100.4 mg, 0.25 mmol) was dried in a vacuum drying oven before it was sealed with a septum and set under argon atmosphere. Dried (Prⁱ)Pd(η³-allyl)Cl (12 mol-%, 7.2 mg, 0.012 mmol) and KO^tBu (2.5 eq, 30 mg, 0.25 mmol) were dissolved in 1.8 mL of degassed 2-propanole and added with a syringe to the reaction vessel. The mixture was stirred for 15 minutes and then **17** (1 eq, 32.4 mg, 0.1 mmol) was added. Afterwards the reaction vessel was degassed with argon, heated to 80°C and stirred over night. The progress of reaction was checked with TLC.

The reaction was quenched by adding 2 mL of water to the test tube, the liquid was transferred to a 50 mL separatory funnel with a syringe. The reaction vessel was washed three times with 1 mL of chloroform, which was also used to extract the mixture in the separatory funnel. The combined organic phase was dried over sodium sulphate, filtrated and the solvent removed under reduced pressure. Afterwards the mixture was separated with MPLC (stationary phase: 40 g silica gel, solvent: cyclohexane with 9% DCM, gradient to 18% DCM). TLC was used to check which fractions contained product, these fractions were combined and the solvent removed under reduced pressure.

27.3 mg (39%) of **20b** were obtained as yellow (slightly orange) solid, which was stored under argon atmosphere in a freezer.

¹H-NMR (400 MHz, CD₂Cl₂): δ = 7.45 (d, J = 8.6 Hz, 4H), 7.13 - 7.09 (m, 12H), 7.01 - 6.97 (m, 12H), 2.32 (s, 12H)

¹³C-NMR (100 MHz, CD₂Cl₂): δ = 148.4 (s), 145.5 (s), 143.5 (s), 136.2 (s), 133.7 (s), 130.5 (d), 127.5 (s), 126.7 (d), 125.4 (d), 124.8 (d), 123.2 (d), 122.7 (d), 21.1 (q) ppm

¹H-NMR is shown on page 69 and ¹³C is shown on page 70.

Summary

This Diploma thesis deals with the synthesis of electroluminescent oligothiophenes which can be used in organic light emitting diodes (OLEDs). In order to find the best and cheapest synthetic pathway for four OLED-substances different reactions were examined, beginning with the synthesis of basic substances. Most reactions were monitored by GC-MS and the purity checked with NMR. In the end, two of the target substances were obtained.

4-Bromoaniline **3** was synthesised by bromination of aniline **4** and catalytic hydrogenation of p-bromonitrobenzene **2**, produced by nitration of bromobenzene **1**. The reduction of **2** was also tried with zinc, which was more promising, so this reaction was optimised by varying the zinc-amount and reaction parameters.

Then, it was tried to synthesise p-Iodotoluene **6** by direct iodation of toluene. Since this reaction did not work, the substance was synthesised out of p-toluidine **5** via diazotation.

The two obtained substances were used for the synthesis of **7** by Ullmann condensation. Although the reaction worked well, the purification turned out to be rather difficult. So a variety of experiments was necessary. In the end, a Kugelrohr distillation was found to be the best solution to achieve a clean product.

Meanwhile, boric-acid triisopropyle ester **9**, produced out of boric-acid, was used for the synthesis of **10**. These and the previously obtained **7** were coupled with n-BuLi to **11**, a precursor of the target substance.

The OLED-substances itself should be produced from **11** and one of four dibromo-oligothiophenes (one to four thiophene rings). These were produced by metalorganic reactions (with n-BuLi or Suzuki), where the purification was optimised. In spite of limited labour time, two of four target substances and three of four dibromothiophenes (last prestage) could be obtained. The obtained target substances were "OLED1" 4,4'-(2,5-thiophenediyl)bis[N,N-bis(4-methylphenyl)-benzenamine] **20a**, which is blue-shining when applying voltage or UV-radiation, and the green-shining "OLED 2" 4,4'-[2,2'-Bithiophene]-5,5'-diylbis[N,N-bis(4-methylphenyl)-benzenamine] **20b**. These two substances are examples for the applicability of the described synthetic pathway.

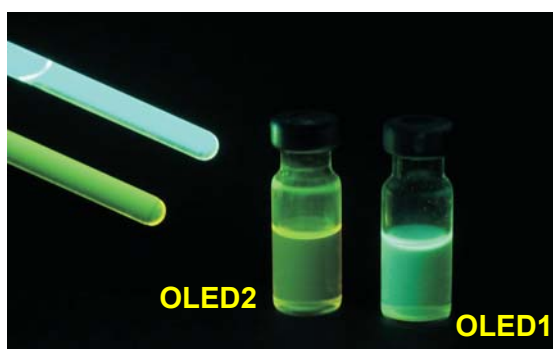
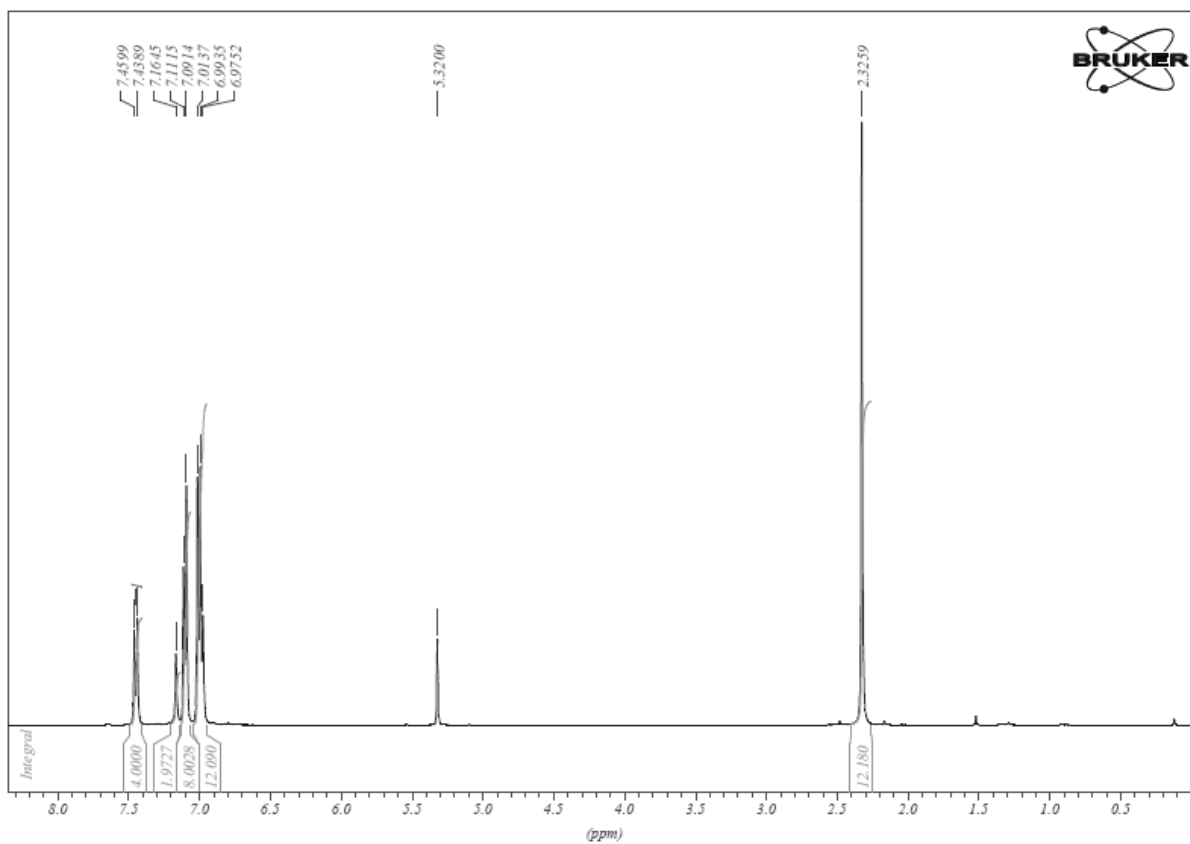

Fig. 32 Fluorescence image of OLED

Appendix

¹H NMRs of target substances

OLED1



OLED2

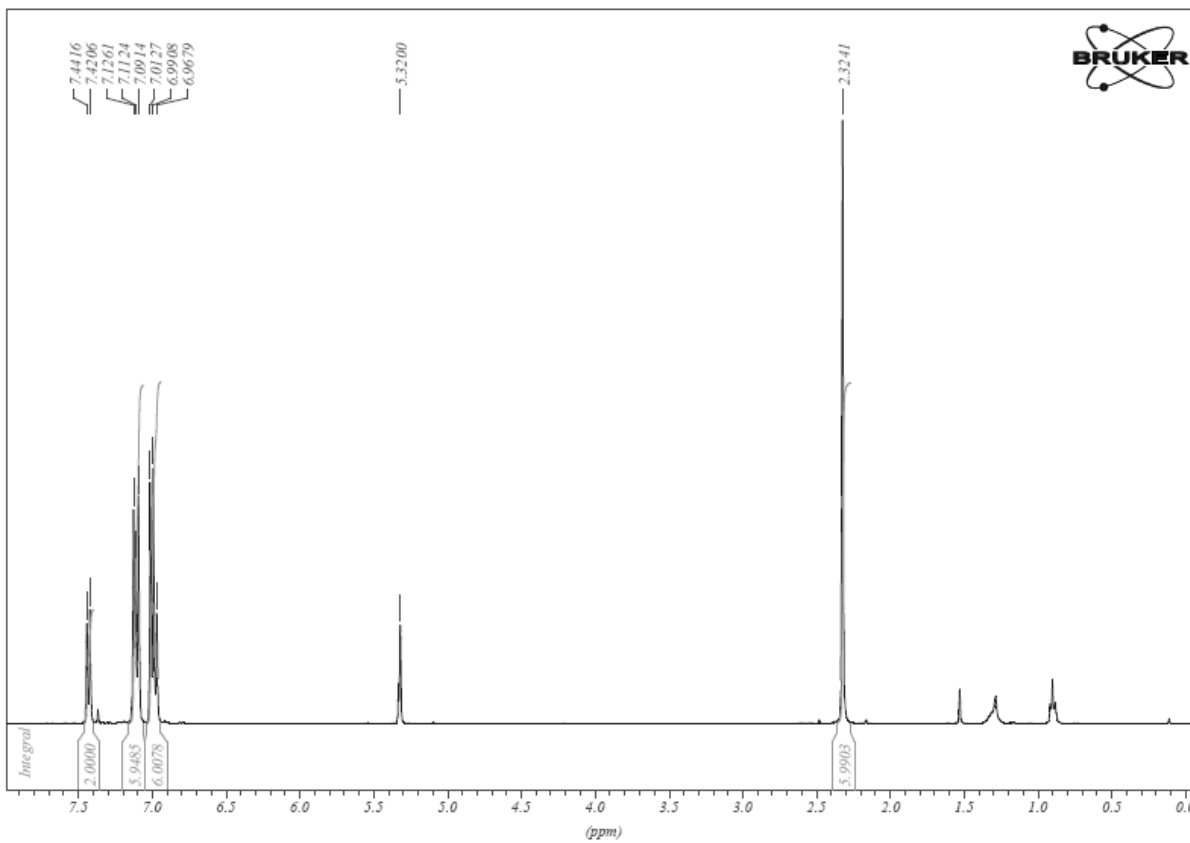

¹³C NMRs of target substances

OLED1

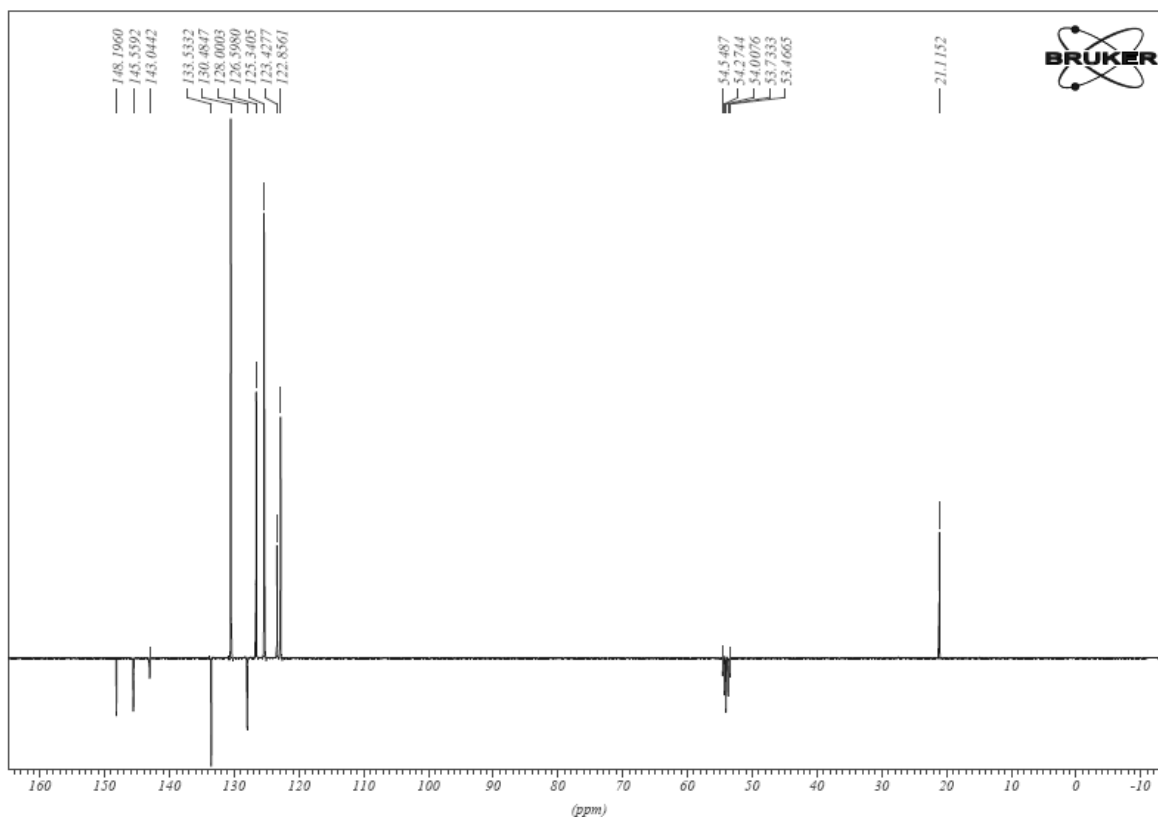

OLED2

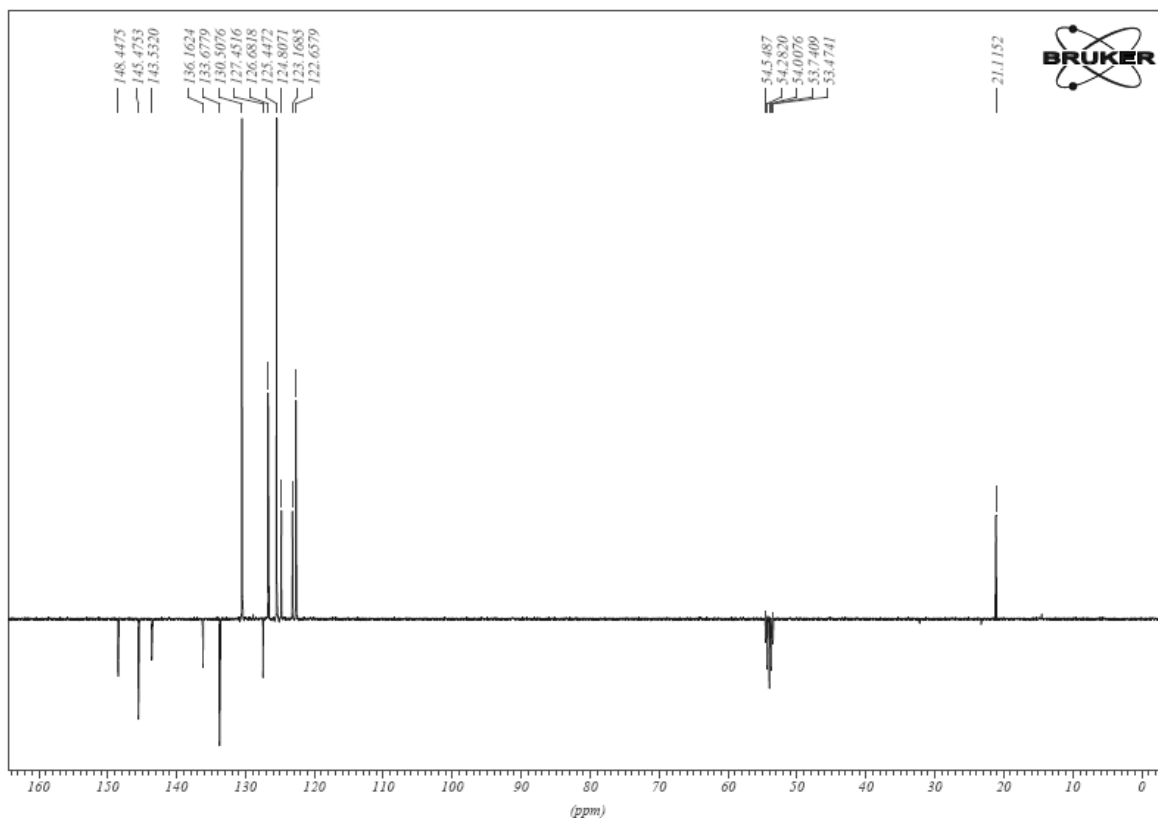

List of abbreviations

e.g.	for example
Fig.	figure
p.	page

Technical abbreviations

DCM	dichloromethane
DME	dimethylether
EE	ethyl acetate
Et ₂ O	diethylether
GC	gas chromatography
GC-MS	gas chromatography-mass spectrometry
HCl	hydrochloric acid
HPLC	high pressure liquid chromatography
ITO	indium tin oxide
LCD	liquid crystal display
MPLC	medium pressure liquid chromatography
MS	mass spectrometry
n-BuLi	n-Butyllithium
NBS	N-Bromisuccinimide
NMR	nuclear magnetic resonance
OLED	organic light emitting diode
PE	light petrol
PET	polyethylene terephthalate
PLED	polymer light emitting diode
R _f	retention factor
SMOLED	small molecule light emitting diode
TFT	thin film transistor
THF	tetrahydrofurane
TLC	thin layer chromatography
TMS	tetramethylsilane

Units

eq	equivalent	min	minutes
g	gram	mL	millilitre
h	hour	mmol	millimol
L	litre	T	Tesla
mbar	millibar	vs	versus
mg	milligram		

Reagents

- (Pri)Pd(η^3 -allyl)Cl:¹
- absolute THF (Donau Chemie, techn.)
- acetic acid (Busetty, Chem. R. 98 – 100%)
- acetic anhydride¹
- activated carbon (Merck, pure)
- ammonium chloride (Sigma Aldrich, 99.8%)
- argon (Messer Austria GmbH, 2.2)
- benzene (Sigma Aldrich, 99.9%)
- boric-acid (Merck, p.a. 99.8%)
- boric-acid trimethyle ester¹
- bromobenzene (Merck, 99%)
- chloroform (Neuber, techn.)
- copper bromide (Sigma Aldrich, 98%)
- copper chloride (Sigma Aldrich, 99%)
- cyclohexane (Merck, p.a.)
- distilled water¹
- dibromothiophene (Fluka, pure 97%)
- dichloromethane (Sigma Aldrich, 99.5%)
- ethanol (Merck, for analysis)
- ether (Donau Chemie, pure)
- HCl (conc) (Donau Chemie, techn. 31%)
- hyflo (VWR)
- ice
- isopropanole (Donau Chemie)
- KO^tBu:¹
- liquid nitrogen:¹
- methanol (Donau Chemie, pure)
- NaCl-solution (Merck, saturated)
- n-BuLi (Sigma Aldrich, 2.5 M solution in hexane)
- n-hexane (Merck, p.a. 99%)
- nitric acid (Merck, p.a. 65%)
- nitrogen (Messer Austria GmbH, 2.2)
- p – toluidine (Merck, p.a.)
- Pd(PPh₃)₄¹
- petroleum ether (Donau Chemie, 40-65%)
- phenantroline (Merck, p.a. 99.5%)
- pinacol (ABCR, 99%)
- potassium carbonate solution (Merck, saturated)
- potassium hydroxide (Merck, p.a. 85%)
- potassium iodide (Merck, p.a. 99.5%)
- silica gel (Sigma Aldrich)
- sodium bisulfite solution (saturated, solid: Sigma Aldrich)
- sodium chloride solution (saturated, Riedel de Häen, solid: p.a. 99.8%)
- sodium hydrogen (saturated, Merck, solid: pure 99%)
- sodium nitrite (Merck, p.a. 99%)
- sodium sulphate (Merck, p.a.)
- sulphuric acid (Merck, p.a. 98%)
- toluene (Donau Chemie, pure)
- urea (Merck, pure)
- water
- zinc (Loba, practical)

¹ Produced by the Vienna University of Technology

Apparatus

- clamps
- condenser
- dean stark trap
- dropping funnel
- filter paper
- four necked flask (500mL)
- funnel
- GC/MS: Thermo Scientific DSQ II
- heating mantle
- jacketed coil condenser
- Kugelrohr distillation apparatus
- low temperature thermometer
- magnetic stirrer
- measuring cylinder (100,500mL)
- mechanical stirrer
- MPLC: BÜCHI Fraction Collector C - 660
- NMR: Bruker DPX – 200
- oil bath
- powder funnel
- separatory funnel
- septum
- spatula
- spoon
- suction flask
- syringe
- thermometer
- three necked flask (50,100,250,500mL)
- TLC chamber
- TLC tubes
- ultra sonic bath
- vigreux column
- volumetric flasks (50,100,250,1000,2000mL)

References

- [1] www.htl17.at/Teatime/schuelerverwaltung/info_engl.pdf (18.3.2009)
- [2] www.oled.at (1.4.2009)
- [3] derstandard.at/?url=/?id=1219725000695%26sap=2%26_pid=10436200(1.4.2009)
- [4] www.bmbf.de/de/3766.php (1.4.2009)

Theoretical part:

OLED

- [5] Müllen, Klaus and Scherf Ullrich. Organic light emitting devices; Synthesis Properties and Application, Weinheim: Wiley VCH Verlag, 2006
- [6] Jopp, Klaus and Froböse, Rolf. Fussball, Fashion, Flachbildschirme, Weinheim: Wiley VCH Verlag, 2006
- [7] Klauk, Hagen. Organic Electronics; Materials, Manufacturing and Applications, Weinheim: Wiley VCH Verlag, 2006
- [8] Chemgapedia: www.vs-c.de (2.12.2008)
- [9] Wikipedia: en.wikipedia.org (21.1.2009)
- [10] www.oled.at (21.1.2009)

NMR

- [11] Perkampus, Heinz-Helmut. Encyclopedia of Spectroscopy, Weinheim: VCH-Verlagsgesellschaft, 1993, S.393-399
- [12] Günzler, Helmut and Williams, Alex. Handbook of Analytical Techniques, Weinheim: Wiley VCH-Verlag, 2001, S.510-535
- [13] Atkins, Peter. Physical chemistry, Oxford: Oxford university press, 2006, S. 513-541
- [14] Ning, Yong-Cheng. Structural Identification of Organic Compounds, Weinheim: Wiley VCH-Verlag, 2005
- [15] Wikipedia: en.wikipedia.org/wiki/NMR (9.12.2008)

GC and MS

- [16] Chemgapedia: www.vs-c.de (2.12.2008)
- [17] Schomburg, Gerhard. Gas Chromatography; A practical course, Weinheim: Wiley-VCH Verlag, 1990, S.34-66
- [18] Ning, Yong-Cheng. Structural Identification of Organic Compounds, Weinheim: Wiley VCH-Verlag, 2005

Suzuki coupling

- [19] Elschenbroich, Christoph. Organometallics, Weinheim: Wiley-VCH Verlag, 2005
- [20] www.organic-chemistry.com (25.3.2009)

Special part

- [21] Tsukinoki, Takehito, *Green Chemistry*, **2001**, Vol. 3, S.37-38
- [22] Biswanath, Katta, *Journal of Molecular Catalysis*, Chemical 267, **2007**, p.30-33
- [23] Pasha, Myint, *Synthetic communication*, **2004**, Vol.34, No. 15, p. 2829-2833
- [24] Hart, Harold. *Organische Chemie*, Weinheim: Wiley VCH-Verlag, 2002
- [25] Cho, Sung Yong, *J.AM.CHEM.SOC.*, **2007**, Vol. 129, 11910-11911 supporting information
- [26] Goodbrand H. Bruce, *J.Org.Chem.*, **1999**, Vol. 64, p. 670-674
- [27] www.organische-chemie.ch/OC/namen/ullmamm.htm
- [28] Andersen, Marc, *Stereoselective synthesis of alcohols, XXX: E- and Z-pentenylboronates, reagents for simple diastereoselection on addition to aldehydes*, **1989**, Vol. 122, S.1777 – 1782
- [29] www.chemguide.co.uk/inorganic/complexions/stabconst.html (11.03.2009)
- [30] Anémian R., *Solution phase studies towards the synthesis of triarylamine oligomers using a germanium linker on a solid support*, **2005**, Vol. 46, p. 6717 – 6721
- [31] Nai-Xing Wang, *Synthesis of 2-Bromo-2'-phenyl-5,5'-thiophene: Suzuki Reaction Versus Negishi Reaction*, **2003**, Vol. 33, No.12, p. 2122, 2003

Experimental part

Melting points

- [32] www.eusdb.de (13.05.2009)
- [33] Goodbrand H. Bruce, Ligand – Accelerated Catalysis of the Ullmann Condensation, Application to Hole Conducting Triarylaminines
- [34] Lucas, Kennedy, Wilmot, *Journal, JACSAT, Journal of the American Chemical Society*, 58, 1936, 157, 159, DOI: 10.1021/ja01329a053, ISSN: 0002 – 7863
- [35] Goodbrand H. Bruce, Ligand – Accelerated Catalysis of the Ullmann Condensation, Application to Hole Conducting Triarylaminines
- [36] Wynberg, Bantjes, *Journal, JOCEAH, Journal of Organic Chemistry*, 24, 1959, 1421, DOI: 10,1021/jo01092a008, ISSN: 0022 – 3263



Sparkling Science >
Wissenschaft ruft Schule
Schule ruft Wissenschaft

oead 

www.bmwf.gv.at
www.sparklingscience.at

BMWF^a

Bundesministerium für Wissenschaft
und Forschung